

# ANNUAL REPORT 2013



# ERCIS

European  
Research  
Center for  
Information  
Systems



BRISBANE AUSTRALIA VIENNA AUSTRIA PRAGUE CZECH REPUBLIC COPENHAGEN DENMARK  
TURKU FINLAND TALENCE FRANCE MÜNSTER GERMANY ROME ITALY VADUZ LIECHTENSTEIN  
KAUNAS LITHUANIA ENSCHEDE NETHERLANDS HAMILTON NEW ZEALAND KRISTIANSAND NORWAY  
GDANSK POLAND ULSAN SOUTH KOREA MARIBOR SLOVENIA ST. GALLEN SWITZERLAND  
NEW JERSEY USA MANCHESTER UNITED KINGDOM MOSCOW + NIZHNY NOVGOROD RUSSIA

[www.ercis.org](http://www.ercis.org)



The ERCIS – European Research Center for Information Systems – is an international network of scientists conducting cooperative research in the field of Information Systems (IS). The Network was founded in 2004 at the University of Münster and is funded by the German State of North Rhine Westphalia and the University of Münster.

The Network provides new ways of thinking and multidisciplinary approaches for finding solutions to the problems arising from an on-going transformation of society and organizations due to the growing impact of IT. ERCIS has dedicated itself to dealing with these challenges through collaboration and exchange of information between research and practice.

ERCIS is notable for excellent communication and uncomplicated initiation of research cooperation and research projects. One of ERCIS' major strengths are the personal contacts between researchers, which makes it a vibrant network. ERCIS covers a wide range of disciplines associated with IS and perspectives on IS research.

The Network is headed by the Board of Directors in Münster, which is composed of one academic director, namely Prof. Dr. Jörg Becker, and eight additional professors all active in the IS research field. Moreover, ERCIS involves numerous internationally renowned researchers from more than 20 associated research institutions, as well as members of the Advisory Board coming from diverse industry companies.

All ERCIS research partners are experts in a wide variety of disciplines related to IS. Research conducted by ERCIS spans from fundamental research to application-oriented research. Besides individual research activities of the ERCIS members, the Network brings together and supports selected research aspects of IS in Competence Centers aimed at strengthening research in specific areas. The Advisory Board members come from various industry sectors, which guarantees that the research conducted at ERCIS is relevant for practice. Regular meetings of the Board of Directors with the Advisory Board members, as well as annual workshops of the ERCIS associated research institutions, ensure continuous, direct and productive exchange of knowledge.

Finally, students and young researchers also benefit from collaboration at ERCIS, as many ERCIS research partners offer exchange programs that last one or two semesters, which gives students an opportunity to acquire international experience. Joint lectures and guest talks organized by several ERCIS members contribute to the internationalization of teaching.

If you are interested in getting in contact with the Network, please feel free to contact us! For further information please visit

[www.ercis.org](http://www.ercis.org)



## DEAR FELLOW ERCIS PARTNERS AND INTERESTED READERS OF THIS REPORT,

What a great year for the ERCIS network! A lot has happened during the last months and I really look forward to the future imagining a lively and active ERCIS network. It is hard to decide, which developments, changes, and successes that happened this year I should start with. First of all, we had a change in the ERCIS Board of Directors this year: Prof. Heike Trautmann succeeded Prof. Ulrich Müller-Funk. In addition, we welcome Prof. Martin Dugas from the Institute of Medical Informatics to our Board of Directors! This extension will definitely bring valuable contribution to the ERCIS network and broaden our scope of research excellence.

Apart from that, we are very happy to welcome several companies that decided to become new ERCIS Advisory Board members: Hilti AG, Deteccon International GmbH, arvato distribution GmbH, Deloitte Consulting GmbH, Johannes Räckers GmbH, PICTURE GmbH, and zeb/ GmbH. In September 2013 we held our annual Advisory Board meeting with our new and old Advisory Board members, where we discussed current research topics like “Bring your own device” or “Big Data”, as well as the possibilities for Advisory Board members to get involved in ongoing research or teaching.

Besides the meeting with the Advisory Board, we also had an extremely interesting ERCIS Annual Workshop in Turku. Interesting, on the one hand, because of the Workshop topic “Education@ERCIS”, and, on the other hand, because of the unusual location: The Workshop took place on a ferry from Turku to Stockholm and back. Thus, we had enough time for discussion and knowledge exchange, but also for enjoying a great view on the archipelago between Finland and Sweden. At this point, my team and I would like to thank Prof. Reima Suomi and his colleagues once again for hosting this year's meeting and making it such a successful and pleasant event. More details about 2013 ERCIS Annual Workshop can be found in this report.

From the northernmost point of the ERCIS network in Finland, we will go all the way down to Italy for our next Annual Workshop in Rome, which will take place September 10<sup>th</sup>–12<sup>th</sup>, 2014. Save the date for this great event!

Regarding teaching, several joint courses could be realized (again) this year: The ERCIS Virtual Seminar, which becomes a tradition among graduate students from several ERCIS partners around the world; the BPM winter school in Liechtenstein with participating undergraduate students from Liechtenstein and Münster; and a successful project seminar for students from Münster with Hilti AG, one of our new Advisory Board members. Next year we will once again have a Doctoral Consortium organized by Prof. Robert Winter from St. Gallen (Switzerland) together with the ERCIS team. We will keep you informed about this event for the Doctoral candidates of the ERCIS network.

All up-to-date information about everything what happens in the Network can always be gathered at one of our ERCIS@conference meetings. As most of our ERCIS partners visit ECIS (European Conference on Information Systems) and ICIS (International Conference on Information Systems), we established our conference meetings there. We have the impression that these informal meetings, where everyone connected to the ERCIS network can have a chat with the others, are really interesting for all of us, both older and younger researchers.

As you can see, a lot has happened in 2013 and I so much look forward to meeting you all in Rome next year for another Annual Workshop and a lively exchange of knowledge within the Network, since, as I always like to stress, “ERCIS is what we make of it”

All the best, Jörg Becker

# TABLE OF CONTENTS

<b>ERCIS NETWORK</b>	02	<b>NEW JERSEY – USA</b>	54	<b>NETWORK RESEARCH ACTIVITIES</b>	88
<b>PREFACE</b>	03	<i>Stevens Institute of Technology</i>		<i>Networked Service Society (NSS)</i>	88
<b>4<sup>TH</sup> ANNUAL ERCIS WORKSHOP IN TURKU</b>	06	<b>PRAGUE – CZECH REPUBLIC</b>	56	<i>Collaboration in the Area of Crisis Management amongst ERCIS Partners</i>	90
<b>SHORT NEWS</b>	08	<i>Charles University in Prague</i>		<i>Researcher Exchange between Ulsan and Münster Guest Researcher from Finland</i>	91
<b>UNIVERSITY OF MÜNSTER – GERMANY (HEADQUARTERS)</b>	10	<b>ROMA – ITALY</b>	58	<i>Robert Winter from Switzerland visits LUISS</i>	91
<i>Institute of Business-to-Business Marketing</i>	10	<i>Luiss Guido Carli University – CERSI</i>		<i>Reima Suomi visits University of St. Gallen</i>	91
<i>Chair for Information Systems and Information Management</i>	12	<b>ST. GALLEN – SWITZERLAND</b>	60	<i>Stuart Dillon presents Joint NSS Paper at the Headquarters</i>	92
<i>IT Security Research Group</i>	14	<i>University of St. Gallen</i>		<i>NITIMes: Marie Curie Initial Training Network on networked Crisis Management</i>	93
<i>Institute of Medical Informatics</i>	16	<b>TURKU – FINLAND</b>	62	<i>Luca Sabini visits Manchester</i>	93
<i>Chair for Information Systems and Logistics</i>	18	<i>University of Turku</i>		<i>Alexander Dreiling gives Talk at the Headquarters</i>	94
<i>Institute for Information-, Telecommunication- and Media Law (ITM)</i>	20	<b>ULSAN – REPUBLIC OF KOREA</b>	64	<i>Research Exchange between Rome and Kristiansand</i>	94
<i>Chair for IS and Interorganizational Systems</i>	22	<i>Ulsan National Institute of Science and Technology (UNIST)</i>		<i>Guest Researcher from the University of Twente at the Headquarters</i>	94
<i>Chair for Practical Computer Science</i>	24	<b>VADUZ – PRINCIPALITY OF LIECHTENSTEIN</b>	68	<i>Joint Publications</i>	95
<i>Quantitative Methods for Logistics</i>	26	<i>University of Liechtenstein</i>		<b>TEACHING@ERCIS</b>	96
<i>Research Group for Communication and Collaboration Management</i>	28	<b>VIENNA – AUSTRIA</b>	70	<i>Joint Bitcoin Seminar</i>	96
<i>Information Systems and Statistics</i>	30	<i>Vienna University of Economics and Business</i>		<i>Joint Seminar Cyber-Physical Systems</i>	96
<i>Chair of Computer Science – DBIS Group</i>	32	<b>WAIKATO – NEW ZEALAND</b>	72	<i>WWU Barcamp 2013</i>	97
<b>INTERNATIONAL PARTNER INSTITUTIONS</b>	34	<i>University of Waikato</i>		<i>BPM Winter School 2013</i>	98
<b>TALENCE – FRANCE</b>	34	<b>COMPETENCE CENTERS</b>	74	<i>Joint ERCIS Seminar</i>	98
<i>Kedge Business School</i>		<i>Cloud Computing</i>	74	<i>German-Russian Seminar EDUPASS</i>	99
<b>BRISBANE – AUSTRALIA</b>	36	<i>ERP</i>	75		
<i>Queensland University of Technology</i>		<i>Connected Organization</i>	76	<b>EVENTS IN THE ERCIS NETWORK</b>	100
<b>COPENHAGEN – DENMARK</b>	38	<i>Conceptual Modeling</i>	78	<i>ERCIS Advisory Board Meeting 2013</i>	100
<i>Copenhagen Business School</i>		<i>E-Government</i>	80	<i>ICIST 2013 Conference</i>	101
<b>ENSCHEDÉ – THE NETHERLANDS</b>	40	<i>ERCIS Lab Russia</i>	82	<i>26<sup>th</sup> Bled E-Conference</i>	102
<i>University of Twente</i>		<i>Service Science</i>	84	<i>6<sup>th</sup> EuroSymposium on Systems Analysis and Design</i>	102
<b>GDANSK – POLAND</b>	42	<i>Smarter Work</i>	86	<i>ICEC 2013</i>	103
<i>University of Gdansk</i>				<b>ADVISORY BOARD</b>	104
<b>KAUNAS – LITHUANIA</b>	44			<i>arvato Bertelsmann</i>	104
<i>Kaunas University of Technology</i>				<i>BISON</i>	105
<b>KRISTIANSAND – NORWAY</b>	46			<i>PICTURE GmbH</i>	106
<i>University of Agder</i>				<i>Räckers</i>	107
<b>MANCHESTER – ENGLAND</b>	48			<i>Deloitte.</i>	108
<i>Manchester Business School</i>				<i>zeb/</i>	109
<b>MARIBOR – SLOVENIA</b>	50			<i>ECWT</i>	110
<i>University of Maribor</i>				<i>Further Advisory Board Members</i>	112
<b>MOSCOW AND NIZHNY NOVGOROD – RUSSIA</b>	52			<b>OUTLOOK FOR 2014</b>	114
<i>Higher School of Economics</i>				<b>ERCIS TEAM</b>	115
				<b>IMPRINT</b>	116





## 4<sup>TH</sup> ANNUAL ERCIS WORKSHOP

The 2013 ERCIS Annual Workshop themed “Education@ERCIS” took place in Turku (Finland) and was kindly organized by Prof. Reima Suomi, our Academic Contact at the Turku School of Economics. To be more precise, the workshop took place on a fairy travelling between Turku and Stockholm (Sweden), which was a completely new and exciting experience, especially when we were passing Schären during a white night!

The workshop started with a welcome reception at a fish restaurant in Turku downtown. 2013 ERCIS Workshop participants included Jörg Becker, Armin Stein, Marcel Heddier, Sara Hofmann, Christian Grimme, and Ulrich Müller-Funk (Münster, Germany), Robert Winter (St. Gallen, Switzerland), Jacek Maślankowski (Gdansk, Poland), Christopher Holland (Manchester, United Kingdom), Bernd Schenk and Jan vom Brocke (Vaduz, Liechtenstein), Alessio Maria Braccini (Rome, Italy), Kęstutis Kapočius and Rimantas Butleris (Kaunas, Lithuania), Fons Wijnhoven (Enschede, Netherlands), Hans Olav Omland (Kristiansand, Norway), Hannu Salmela and Reima Suomi (Turku, Finland) who hosted the meeting.

The Workshop day started with a recap of the last year activities at ERCIS followed by an introduction to EU funding opportunities digested and presented by Sara Hof-

mann. During this session the participants discussed the potential support from ERASMUS Academic Networks. As stated on the website of ERASMUS programme, “ERASMUS Academic Networks are designed to promote European cooperation and innovation in specific subject areas. They contribute to enhancing quality of teaching in higher education, defining and developing a European dimension within a given academic discipline, furthering innovation and exchanging methodologies and good practices. This is achieved by means of cooperation within the network between higher education institutions, university faculties and departments and may also involve professional associations and enterprises as well as other organizations”. Although it exactly sounds like what ERCIS is doing already, there are several formal hindrances preventing ERCIS to participate in this initiative: At least 25 participants from a minimum of 25 different countries have to participate and the funding cannot exceed 600000 Euro for three years for the whole consortium. Nevertheless, a task force at ERCIS was set up to follow up on this idea and to prepare suggestions and alternatives.

During the next session Fons Wijnhoven presented a new method applied at the University of Twente called “TEM”. This method should address modern students

(iStudents) who tend to have a limited attention span and consume most information virtually. Traditional lectures are uninteresting and uninspiring for iStudents, which raises a call for development of new teaching methods to keep them attracted. One way to tackle this challenge is to make education entirely virtual (see e.g. <https://www.udacity.com/>) meaning that no more physical presence at all is required from the students. The University of Twente, however, has discovered another way for engaging iStudents and offers a student project requiring 40 hours per week workload (15 ECTS) and aimed at solving some practical challenge usually announced by a company, which is also involved in the project. As challenges from practice cannot be solved by simply “googling” the solution, high learning impact is expected. Similar projects are being offered by the University of Münster and the LUISS Guido Carli University.

The participants agreed that university education in the future most likely would not be completely virtual, but rather both aforementioned scenarios would co-exist. However, the virtualization trend should be carefully followed and, if applicable, integrated into existing curricula.

Such a conclusion has made a smooth transition to the third session, where Jan

vom Brocke presented the concept of the 2013 ERCIS Virtual Seminar (<http://virtual-seminar.ercis.org/>), which takes place third year in a row. The Seminar idea stems from discussions between ERCIS members during several conferences and workshops, which have revealed a demand for a broader perspective on BPM (Business Process Management) education. Although it is still a common practice to teach under the BPM umbrella modelling languages, like EPC or BPMN, or concepts like workflow management, recent studies call for a more holistic view on BPM and consideration of such aspects as strategy, governance, culture, and people. ERCIS Virtual Seminars employ this holistic approach and offer students to participate in a real life international project, which might lead to scientific publications. The participating students are divided into groups, where, in the best case, each student comes from a different university. None of the team members should know each other in advance. The students’ tasks are to set means of virtual collaboration with each other and to jointly work on an announced topic. The students have to write a seminar paper or a report and to present the results during mid-term and final presentations. Moreover, students have to regularly report on their virtual collaboration experiences by filling the provided Agility Portfolios. Strong ties between ERCIS partners and other participating universities allowed to minimize the bureaucratic overhead related to the Seminars. This year, however, the supervision efforts are higher than usual due to a very large number of participants (sixty students from seven universities). Each participating university chose the most suitable format for the Seminar, an elective course in the best case. We hope that next year the number of participating ERCIS partners will further increase.

In the next session PhD education was discussed and here Marcel Heddier introduced a concept of joint PhD supervision, which is already now offered by such ERCIS partners as the University of Münster, the University of Liechtenstein and the



Queensland University of Technology. External supervisors have to be well-known to host departments in order to build reliable mentoring and evaluation processes. The ERCIS network seeks to involve more partners into this initiative, as education of young researchers is one of the most important tasks for the scientific community.

Next year it is planned to have a PhD colloquium in St. Gallen (Switzerland) organized by Robert Winter. As it was mentioned above, one of the goals of the ERCIS network is “promotion of young and talented researchers”, as well as “promotion of academic/scientific education and training” (§1(1)5+6 of the ERCIS “Responsibilities and Objectives”). The Network consists of similar-minded researchers working in different fields related to the IS discipline. Therefore, it provides a perfect environment for training and education of young IS researchers. The Colloquium will be opened for 2<sup>nd</sup> (or later) year PhD students from the ERCIS partner institutions. It is planned that 10–15 PhD students will be supervised by 4–5 faculty members. PhD students will present and discuss research they are doing and will have an opportunity to receive in-depth feedback on their work. The participants will be rewarded with 3 ECTS or similar. The Colloquium workload will include around 20–25 contact hours and 65–70 hours preparation

time. Later we will provide more details on our website ([www.ercis.org](http://www.ercis.org)).

During the final session of the 2013 ERCIS Annual Workshop an approach to education offered at the University of Agder was discussed: The main idea is to connect 2nd year Master students and last year Bachelor students together with one or two Master students have to develop an Information System for a company. The students also have to write a report on how a project was managed. Each project is very extensive and provides Bachelor students with 20 ECTS and Master students with 10 ECTS. Master students are often being seen as project managers, although usually they just observe the settings. Students’ experience is positive, which makes this approach attractive to be adopted by the other ERCIS partners.

The Workshop was finalized with a trip to Turku castle, where it was decided that the next 2014 ERCIS Annual Workshop will take place in Rome (Italy) September 10<sup>th</sup>–12<sup>th</sup>, 2014. Save the date!





### ERCIS ORGANIZES ECIS 2015

The preparations for ECIS 2015, which will be hosted by the ERCIS headquarters in Münster, are in full swing. Jörg Becker, together with Marco de Marco from Italy and Jan vom Brocke from Liechtenstein, will be the conference chairs. The proposed conference theme matches the idea of our ERCIS network: "The Networked Society". ECIS 2015 should be a meeting place for European and also non-European researchers in the field of Information Systems from various cultures and countries and should reflect the specific and innovative research in Information Systems dealing with the overarching networked society.

[www.ecis2015.eu](http://www.ecis2015.eu)

### ADVISORY BOARD MEMBER ZEB/ SPONSORS BEST THESIS AWARD

The advisory board member zeb/ has awarded the best Bachelor as well as Master thesis within the study programme "Information Systems" at the headquarters. In the undergraduate programme, Jan Betzing has received the award for his Thesis. He developed a Drupal module for handling the management of theses at the ERCIS headquarters. In the graduate programme, Friedrich Chasin was awarded for his thesis "The Genealogy of Knowledge in Wikipedia – Method Development and Application". Both were given an iPad mini sponsored by zeb/.

### ERCIS TEAMS VISITS MEMBER INSTITUTIONS

In order to further promote the network activities along its members as well as to record the members' wishes and ideas, the ERCIS team has continued its series of visits to the ERCIS partners in 2013. During this year, Katrin, Sara, Armin and Marcel were in Prague, Turku, Rome, Brisbane and Hamilton, where they presented the benefits of being a member in the ERCIS network to faculty and PhD students. They exchanged ideas on how to collaborate both in the area of research as well as by joint teaching activities.



### PERMANENT SUPPORT FOR THE ERCIS TEAM

We are happy to announce that Katrin Bergener, who has been part of the ERCIS team during her PhD studies and has finished her PhD in 2013, now holds a post-doctoral position at the headquarters. Together with Armin Stein, she will now be a permanent member in the ERCIS team. She will continue her tasks in supporting the ERCIS network by organizing events, being responsible for marketing materials and managing the contact with the ERCIS members.

### ERCIS@ECIS 2013

By now it has almost become a good tradition to have an informal ERCIS meeting at the ECIS conference. This year in Utrecht, we met in one of the seminar rooms of the university for a few drinks, a chat and some interesting talks about new contact persons in the network, researcher exchange possibilities, and other activities that are currently going on in the network.



### MARTINA COMES FROM NORWAY TALKS AT ERCIS LUNCHTIME SEMINAR

This year, the ERCIS Lunchtime seminar was held for the fourth consecutive semester and thus has become a well-established event at ERCIS headquarters. Like in previous years, a broad range of topics, such as IT Security, Game Theory, Cloud Computing, Data Marketplaces, Small and Medium-sized Enterprises (SMEs) and ICT, as well as process modelling was presented and discussed during Tuesday's Lunch Sessions. Besides several speakers from the ERCIS Headquarter, many national and international guest speakers presented their research in the IS domain.

In May, Dr. Martina Comes from the ERCIS member University of Agder in Norway gave a talk at the ERCIS Lunchtime Seminar in Münster. In her presentation "Decision Support in Emergency Management: Confronting Complexity and Uncertainty" Martina talked about the challenges of efficient disaster management like the disruption of Critical Infrastructures.

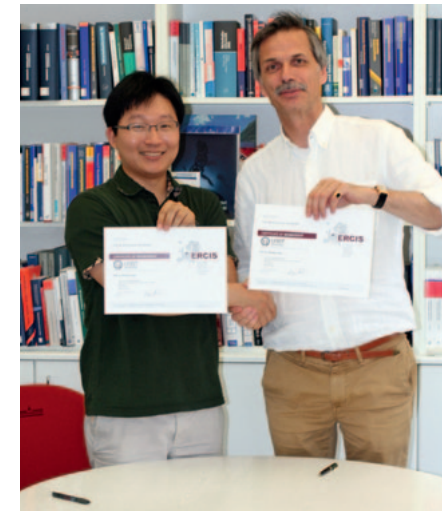

### NEW ERCIS PARTNER IN SOUTH KOREA

Following up on the research cooperation in the Networked Service Society (NSS) project, we proudly welcome Prof. Dr. Min-seok Song as our new ERCIS partner in Korea. Being situated in Korea's number one industrial area, the Ulsan National Institute of Science and Technology (UNIST) was initiated by the Korean Government in 2010, starting a rapid development towards an internationally renowned university. Professor Song's workgroup is focused on Business Process Mining and has frequently collaborated with industrial companies in this area. All lectures at UNIST are given in English, establishing an international working atmosphere.

As regards joint teaching, students and lecturers of UNIST take part in the current ERCIS virtual seminar on Business Process Management. As our only partner in Eastern Asia, their involvement adds a truly intercultural perspective!

We look forward to launching new joint research projects and publications in the years to come!

### SEVEN NEW ERCIS ADVISORY BOARD MEMBERS AND ERCIS YEARBOOK

In 2013, the ERCIS advisory board has grown by seven new members. We are happy to welcome arvato Bertelsmann, Deloitte Consulting GmbH, Detecon International GmbH, Hilti Corporation, Johannes Räckers GmbH & Co. KG, PICTURE GmbH and zeb/ on board. In 2014, the series of new advisory board members will continue with Saracus Consulting GmbH, which will join the advisory board in January.

The new advisory board members are looking forward to getting into contact with the ERCIS students, e.g. by conducting joint project seminars. In this context, we have launched the first version of the ERCIS Yearbook. The yearbook is a compilation of students from the headquarters who are about to finish their studies and are looking for a job. In 2014, we will extend the ERCIS Yearbook to interested ERCIS partners.



### JÖRG BECKER RECEIVES HONORARY DOCTORATE

Jörg Becker, the Academic Director of the ERCIS network has been granted an honorary doctorate by the Voronezh State University, Russia. A ceremony was held on this occasion in the Voronezh State University's (VSU) main building in Central Russia in November 2013. Jörg Becker received this honorary title in recognition of his worldwide research in Business Informatics and in active promotion of German-Russian research cooperation.



### BEST STUDENT PAPER AWARD FOR ERCIS MEMBER STUDENT AT WI CONFERENCE

Sanja Tumbas and Dr. Theresa Schmiedel were assigned the Hilti Best Student Paper Award for their publication "Developing an Organizational Culture Supportive of Business Process Management" presented at the 11<sup>th</sup> International Conference on Wirtschaftsinformatik (WI) in Leipzig.

The paper was based on the master thesis project conducted under joint supervision of the Chair for Information Systems and Information Management, University of Münster and Institute of Information Systems, University of Liechtenstein.

### TWO NEW ERCIS DIRECTORS AT THE ERCIS HEADQUARTERS

The ERCIS welcomes two new directors at the ERCIS headquarters: Prof. Dr. Heike Trautmann and Prof. Dr. Martin Dugas joined the board of directors in 2013. Heike Trautmann is the successor of Ulrich Müller-Funk, who now is an emeritus professor. She is head of the Information Systems and Statistics group at the ERCIS headquarters. Martin Dugas leads the Institute of Medical Informatics at the University of Münster.





## ABOUT THE INSTITUTION

The Institute of Business-to-Business Marketing (IAS) is part of the ERCIS Headquarters located in Münster and represents the first senior professorship under the roof of the Marketing Center Münster (MCM).

Business-to-Business Marketing is traditionally the main research area of the IAS. In addition, the research program is continuously expanded to other interesting and current areas of research, such as the emergence of dominant designs and service marketing. Parts of the research program are realized with the help of associates from research and industry.

The IAS has recently started to extend scenario analysis techniques in a research project together with the University Hospital Münster and the Institute of Public Auditors in Germany.

Beyond high-quality research, the IAS has always defined itself through outstanding educational efforts. We maintain close ties with partners from a variety of industries and academic institutions all over the world to offer our marketing students compelling lectures and extraordinary seminars.

This winter semester the IAS offers a course on industrial marketing for master students in Münster. Additionally, professor Backhaus is mainly responsible for the development of the curriculum for the Bachelor program in Business Administration for the Turkish-German University in Istanbul. Following the finalization of the



curriculum he took over the responsibility of organizing the flying faculty from Germany as the program officially started in September with the enrollment of the first students.

## RESEARCH TOPICS

Our research mainly focuses on topics from Industrial Marketing.

One of the key areas represents the field of negotiation analysis. The outcome of this work has been published in internationally reviewed and highly ranked Journals. Beside that, the results of this applied research have, inter alia, been documented in the following five definitive textbooks: "Industriegütermarketing", "Strategisches Marketing", "Multivariate Analysemethoden", "Fortgeschrittene Multivariate Analysemethoden", and "Vermarktung hybrider Leistungsbündel". The high quality of these publications has been highlighted by several awards, among those the renowned Georg-Bergler-Preis 2008 and the Transferpreis 2010 of the University of Münster for their outstanding link between practice and science within the project "H2-ServPay".

## CURRENT RESEARCH PROJECTS

Current research at the IAS is divided in two sections. In institutionally funded research projects, the IAS collaborates closely with industrial companies and practice-oriented

associations to generate knowledge with a direct impact for the industry. Further research is focused on relevant topics in the international field of Marketing and conducted in the course of (cumulative) dissertation projects.

The IAS has been working on a cooperative research project together with the Chair for Information Systems and Information Management in Münster and the Chair for International Marketing at the ESCP Berlin. The core focus of the project is the quantification of productivity in industrial services with the help of Data-Envelopment-Analysis (DEA). The publicly funded study represents a follow-up of the award-winning "H2-ServPay" project.

In cooperation with the Institute of Accounting and Auditing in Münster and the Institute of Public Auditors, the IAS uses scenario analysis to assess the challenges and chances auditors will face in the year 2025. Recently, the IAS started to work with the University Hospital Münster in order to further develop scenario analysis techniques. Although not a Marketing topic, we use our expertise in multivariate methodology to provide a substantial contribution to the goals of the project.

Moreover, the IAS is part of the leading-edge cluster "it's OWL". In collaboration

with industrial companies located in eastern Westphalia, the IAS continuously expands its expertise in multivariate methodology by developing a statistical method that is able to test the acceptance of technological complex innovations.

We continue to deliver relevant insights with focus on negotiations research and the emergence of dominant designs.

## PUBLICATIONS

### Dissertations

*Motullo, Marco:* Adoption und Nutzung sozialer Online-Netzwerke: Empirische Analysen zur Erklärung und Prognose des individuellen Nutzerverhaltens

*Neun, Harald:* Verhandlungen im internationalen Vertrieb: Empirische Analysen kultureller Einflüsse in intra- und internationalen Verhandlungen

*Zerres, Alfred:* Negotiation in B2B-Marketing – Cumulative Evidence and Innovative Insights from Experimental Research.

*Rossinelli, Christina:* Methodische Gestaltungsparameter zur Auswahl von Schlüsselfaktoren in Szenarioanalysen – Eine konzeptionelle und fallbeispielbasierte Untersuchung –

*Lügger, Kai:* Strategische und operative Vertriebsentscheidungen im Industriegütermarketing – ausgewählte konzeptionelle und empirische Befunde

### Habilitations

The IAS employs Dr. Michael Steiner as Assistant Professor. Michael Steiner's research activities focus on brand management and consumer behavior (especially preference measurement).

### Articles in International Journals

*Hüffmeier J., Freund, P. A., Zerres, A., Backhaus, K., Hertel, G.:* Being tough or being nice? A metaanalysis on hard- and soft-line strategies in distributive negotiations, in: Journal of Management.

*Eisenbeiss, M., Backhaus, K., Blechschmidt, B., Freund, P. A.:* "The (real) world is not enough": Motivational drivers and user behavior in virtual worlds, in: Journal of Interactive Marketing.

*Backhaus, K., Lügger, K., Koch, M.:* The structure and evolution of business-to-business marketing: A citation and co-citation analysis, in: Industrial Marketing Management.

*Backhaus, K., Steiner, M., Lügger, K.:* To invest, or not to invest, in brands? Drivers of brand relevance in B2B markets, in: Industrial Marketing Management.

*Backhaus, K., Stingel, S., Koch, M.:* Biased tariff choices: Exploring role effects in B2B settings, in: Journal of Business-to-Business Marketing.

*Zerres, A., Hüffmeier, J.:* Too many cooks spoil the soup: How negotiating teams deteriorate the negotiators relationship, in: Die Betriebswirtschaft (DBW).

*Zerres, A., Hüffmeier, J., Freund, P. A., Backhaus, K., Hertel, G. (im Druck):* Does it take two to tango? Longitudinal effects of unilateral and bilateral integrative negotiation training, in: Journal of Applied Psychology

*Lügger, K.:* Das B2B-Marketing zwischen Emanzipation und Reintegration, in: Die Betriebswirtschaft.



## CONTACT DETAILS

**PROF. DR. DR. H. C. KLAUS BACKHAUS**  
Institute of Business-to-Business Marketing

University of Münster  
Königsstraße 47  
48143 Münster, Germany  
P +49 251 83-22861  
[www.marketingcenter.de/ias](http://www.marketingcenter.de/ias)  
[ias@uni-muenster.de](mailto:ias@uni-muenster.de)

## KEY FACTS

### INSTITUTION

- Founded in 1986
- Researchers: 10

### RESEARCH TOPICS

- Industrial Marketing
- Negotiation Behavior
- Standardization Processes
- Internationale Marketing

### EVENTS

Marketing Alumni Symposium – wie klarkommen mit der digitalen Revolution? Herausforderungen an die marktorientierte Unternehmensführung





## ABOUT THE INSTITUTION

The Chair for Information Systems and Information Management at the University of Münster, directed by Prof. Dr. Dr. h.c. Jörg Becker, Professor h.c. (NRU-HSE, Moscow), currently comprises ten postdocs and 20 research assistants. The courses offered by the Chair for BSc and MSc in Information Systems study programs include Application Systems, Information Modeling, and Workflow Management (Process Modeling field), as well as Data Management and Management Information Systems and Data Warehousing (Data Modeling field). Members of the Chair are involved in research projects funded nationally and internationally. They publish results of their work in journals like BISE (Business & Information Systems Engineering), BPMJ (Business Process Management Journal), Electronic Markets, EMISA (Enterprise Modeling and Information Systems Architectures), ISeB (Information Systems and E-Business Management), GIQ (Government Information Quarterly), and SJIS (Scandinavian Journal of Information Systems), as well as in conference proceedings like ECIS (European Conference on Information Systems), ER (International Conference on Conceptual Modeling), HICSS (Hawaii International Conference on System Sciences), and ICIS (International Conference on Information Systems).

## SELECTED RESEARCH TOPICS

**Conceptual modelling** has become a mainstream method for describing, designing and reorganizing Information Systems in the last decade. Many large companies use conceptual models for such common tasks as business process reengineering, software introduction, and compliance management. Conceptual Modelling, when being transferred into practice, supports creation of business value for companies and governmental organizations.

**Retail** is another area of research interest at the Chair, which is focused on organizations and application systems in the respective domain including wholesale, stationary retail and e-commerce. Focal topics to account for interdependencies between an organization and an application system involve process management and conceptual modelling in retail, as well as Enterprise Resource Planning (ERP) systems.

**E-Government** deals with the aspects of administrative processes and services within governmental and inter-governmental organizations and the citizens and businesses through the use of Information and Communication Technology (ICT). E-Government links the field of the strategic management with aspects of process management and economic viability and focuses on front- and back-office. E-Government topics can be addressed in terms

of content, as well as from technical and conceptual perspectives.

**Service Science** research addresses such aspect as servitization - the integration of industrial machinery with customized service offerings without selling physical goods. Our research is focused on understanding and facilitating the creation of value in service systems, which involves interactions between service providers and service customers. The goals of the Service Science team at the Chair are to develop a sound theory on service phenomena and to design innovative IT artefacts supporting competitive edge of the service economy.



## SELECTED CURRENT RESEARCH PROJECTS

**Networked Service Society (NSS):** In the first phase of the NSS project the cooperation with the ERCIS partners in Australia (Queensland University of Technology) and New Zealand (University of Waikato) was strengthened and new ties with South Korea (Ulsan National Institute of Science and Technology) were established. The goal of the second phase of the project, which lasts until the end of 2014, is to further institutionalize these structures. As a result, a 'Global Service Research Center' will be established as a Competence Center at ERCIS. Cooperation is already being done in the areas of Joint Education, Joint Research and Joint Industry Projects. The project's long-term goal is to align existing project activities with those done by ERCIS in cooperation with the BRICS (Brazil, Russia, India, China, and South Africa) countries. For further information please visit [www.networkedservicesociety.net](http://www.networkedservicesociety.net)

## SERVDEA

**Productivity Benchmarking for Industrial Services: Design and Evaluation of Adaptions for the Data Envelopment Analysis (ServDEA):** The research project ServDEA employs the data envelopment analysis (DEA) method to develop a software tool, which is capable of benchmarking so-called product-service-systems (often described as "Hybride Leistungsbündel" or customer solutions). For further information please visit [www.servdea.de](http://www.servdea.de)

## SELECTED AWARDS

**Prof. Dr. Dr. h.c. Jörg Becker, Prof. h.c. (NSU-HSE, Moscow)** was awarded a German Computer Science Association fellow.

**Best Paper Award:** *Möser, M., Böhme, R., & Breuker, D. (2013).* An Inquiry into Money Laundering Tools in the Bitcoin Ecosystem. In Proceedings of the APWG eCrime Researchers Summit (ECRIME 2013), San Francisco, USA.

**Best Paper Nominee:** *Beverungen, D. (2013).* On the Design of IT Artifacts and the Emergence of Business Processes as Organizational Routines. In Proceedings of the 34th International Conference on Information Systems (ICIS), Milan, Italy.

## SELECTED PUBLICATIONS

Please see <https://www.wi.uni-muenster.de/departments/groups/is/publications> for a complete list of publications.

*Becker, J., Beverungen, D., Knackstedt, R., Matzner, M., Müller, O., & Pöppelbuß, J. (2013).* Designing Interaction Routines in Service Networks: A Modularity and Social Construction-Based Approach. *Scandinavian Journal of Information Systems*, 25(1), 37–68.

*Dietrich, H.-A., Breuker, D., Steinhorst, M., Delfmann, P., & Becker, J. (2013).* Developing Graphical Model Editors for Meta-Modelling Tools — Requirements, Conceptualisation, and Implementation. *Enterprise Modelling and Information Systems Architectures*, 8(2), forthcoming. (In press)

*Hofmann, S., Beverungen, D., Räckers, M., & Becker, J. (2013).* What Makes Local Governments' Online Communications Successful? Insights from a Multi-Method Analysis of Facebook. *Government Information Quarterly*, in press. (Accepted)

*Knackstedt, R., Heddier, M., & Becker, J. (2013).* Conceptual Modeling in Law: An Interdisciplinary Research Agenda. *Communications of the AIS (CAIS)*, 33. (In press)

*Niehaves, B., & Plattfaut, R. (2013).* Internet adoption by the elderly: employing IS technology acceptance theories for understanding the age-related digital divide. *European Journal of Information Systems* (In press)

## DISSERTATIONS/HABILITATIONS

*Bergener, Katrin:* Supporting Virtual Creative Groups in Organizational Contexts – Theoretical Foundations and Artifact Design.

*Bergener, Philipp:* Analysis of Semantic Business Process Models – Techniques Supporting Business Process Improvement and Compliance Checking.

*Eggert, Mathias:* Compliance Management in Financial Industries – A Model-based Business Process and Reporting Perspective.

*Fleischer, Stefan:* Konstruktion und Anwendung eines multizweckorientierten hierarchischen Metamodellierungswerkzeugs.

*Plattfaut, Ralf:* Process-Oriented Dynamic Capabilities – Framework Development, Empirical Applications, and Methodological Support. Dissertation.

*Voigt, Matthias:* Design and Evaluation of an Architecture for Creativity Support Systems: Supporting Creative Processes in Organizations and Groups.



## CONTACT DETAILS

**PROF. DR. DR. H.C. JÖRG BECKER, PROFESSOR H.C. (NRU-HSE, MOSCOW)**  
Chair for Information Systems and Information Management

University of Münster  
Leonardo-Campus 3  
48149 Münster, Germany  
P +49 251 83-38100  
F +49 251 83-38109  
[www.wi.uni-muenster.de/is](http://www.wi.uni-muenster.de/is)  
[becker@ercis.uni-muenster.de](mailto:becker@ercis.uni-muenster.de)

## KEY FACTS

### INSTITUTION

- 10 Post Docs
- 20 Research Assistants
- 24 Student Assistants

### RESEARCH TOPICS

- Process Management
- Conceptual Modelling
- Retail
- E-Government
- Service Science
- Business Intelligence



# UNIVERSITY OF MÜNSTER – IT SECURITY RESEARCH GROUP



## ABOUT THE GROUP

In a world where computer networks form a vital backbone of wealth and growth, a sound understanding of the principles of security and privacy are no longer the sole domain of spies and specialists. Instead, knowing about information security belongs to the set of indispensable skills for every businessperson and citizen – just like in the offline world where everyone knows how to operate a door lock, or not to issue a blank check. The IT Security Research Group at the Department of Information Systems takes an interdisciplinary approach to a range of research questions in information security and privacy (see figure). Members of the group are particularly interested in the economics of information security and privacy, multimedia security, cybercrime, digital forensics, privacy-enhancing technologies, and usable security. Rainer Böhme, Assistant Professor at WWU Münster since September 2010, heads the group.

## OUTREACH

Members of the IT security group are popular experts and speakers around the globe. In 2013, there was hardly a week where all members of the team were on the same continent. Here are selected examples of what we are up to.



State College, Pennsylvania, USA – Pascal Schöttle, PhD student in the security group is visiting researcher at the Pennsylvania State University (PSU). Hosted by Jens Grossklags of PSU's College of Information Science and Technology, Pascal Schöttle joined a team of researchers from the Budapest University of Technology and Economics and the University of California at Berkeley to investigate game-theoretic approaches to information security. Among other things, the team developed a strategy to staff secret projects while minimizing the probability of undesired information leaks. The research visit is funded by the Office of Naval Research, a scientific branch of the US Navy.



Newcastle, UK – Stefan Korff, 2<sup>nd</sup>-year master student and research assistant in the security group, presents already his second academic paper at the Workshop on Home Usable Privacy affiliated with the Symposium on Usable Privacy & Security, the premier international venue for research on human-computer interaction for the sake of security and privacy. Its social event included a lesson on broomstick riding in the famous Alnwick castle, set of the Harry Potter movies. Less magically, Stefan Korff's trip is sponsored by a grant from Microsoft.



Dallas, Texas, USA – Markus Riek, PhD student and recent hire of the security group, visits cybercrime expert Tyler Moore at SMU Texas to evaluate the indirect costs of cybercrime using statistical path models on large-scale representative population surveys. Markus Riek has specialized in this area for his master thesis and is going to work on a European project set out to study the effects of cybercrime on non-ICT sectors from early 2014. His research visit is supported by the German Academic Exchange Service (DAAD).



Guangzhou, Guangdong, China – Matthias Kirchner speaks at the IEEE International Workshop on Information Forensics and Security (WIFS). He represents the winning team of the first IEEE Image Forensics Challenge, which also includes his colleagues Thomas Gloe (TU Dresden) and Christian Riess (Stanford). The team has managed to identify all forgeries hidden in 5 700 images provided by the organizers of the challenge without any error in just a couple of days. This surprisingly quick breakthrough success has led the organizers to hide the detection rate in the official hall of fame in order to not discourage other teams from working on the challenge. Matthias Kirchner's trip is funded by the IEEE Signal Processing Society.

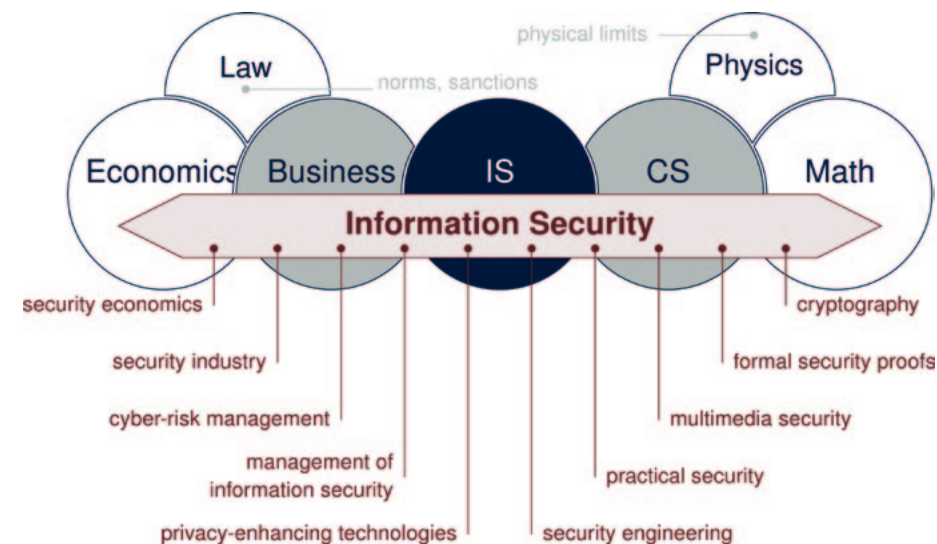

An Interdisciplinary Approach to Information Security

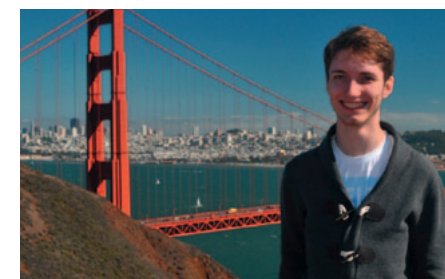

San Francisco, California, USA – Malte Möser, at the time 3<sup>rd</sup>-year undergraduate student and research assistant in the security group, presents an extended version of his seminar thesis on money laundering using the Bitcoin virtual currency to a select audience of international cybercrime fighters. He followed an invitation by the Anti-Phishing Working Group (APWG), the largest international industry association devoted to the fight against financial cybercrime, who also funded his trip. This is an offer one cannot decline, even if the deadline for the Bachelor thesis is only two weeks after the event.

## PUBLICATIONS (SELECTION)

Böhme, R. (ed., 2013): The Economics of Information Security and Privacy, Springer-Verlag, Berlin Heidelberg, 315 p.

Bruns, I., & Luhn, S. (2013): Verbraucherschutz durch Mitentscheidung bei Online-Verträgen. In Law as a Service (LaaS) – Recht im Internet- und Cloud-Zeitalter, Tagungsband Herbstakademie 2013, Berlin, 859–874.

Kirchner, M., Winkler, P. & Farid, H. (2013): Impeding Forgers at Photo Inception. In A.M. Alattar et al. (eds.): Media Watermarking, Security, and Forensics 2013, Proceedings of SPIE-IS&T Electronic Imaging, SPIE Vol. 8665, 86653.

Laszka, A., Johnson, B., Schöttle, P., Grossklags, J., & Böhme, R. (2013): Managing the Weakest Link: A Game-Theoretic Approach for the Mitigation of Insider Threats. In Proceedings of the 18<sup>th</sup> European Symposium on Research in Computer Security, ESORICS 2013, Egham, Großbritannien, 273–290.

Möser, M., Böhme, R., & Breuker, D. (2013): An Inquiry into Money Laundering Tools in the Bitcoin Ecosystem. In Proceedings of the APWG eCrime Researchers Summit (ECRIME 2013), San Francisco, USA.

Ryu, S.-J., Kirchner, M., Lee, M.-J. & Lee, H.-K. (2013): Rotation Invariant Localization of Duplicated Image Regions Based on Zernike Moments. IEEE Transactions on Information Forensics and Security 8 (8), 1355–1370.

Lai, S.-Y., & Böhme, R. (2013): Block Convergence in Repeated Transform Coding: JPEG-100 Forensics, Carbon Dating, and Tamper Detection. In Proceedings of the IEEE International Conference on Acoustics, Speech and Signal Processing, ICASSP 2013, Vancouver, BC, Canada, 3028–3032.



## CONTACT DETAILS

PROF. DR.-ING.  
RAINER BÖHME, M.A.  
IT Security Research Group

University of Münster  
Leonardo-Campus 3  
48149 Münster, Germany  
P +49 251 83-38230  
[www.wi.uni-muenster.de/security](http://www.wi.uni-muenster.de/security)  
[boehme@ercis.de](mailto:boehme@ercis.de)

## KEY FACTS

### INSTITUTION

- Launched in fall 2010
- one professor, one post-doc, four PhD students, three research assistants

### RESEARCH TOPICS

- Economics of Information Security
- Digital Forensics
- Cybercrime
- Steganography and Steganalysis
- Privacy-Enhancing Technologies
- Economics of Privacy
- Security and Usability





## ABOUT THE INSTITUTION

The Institute of Medical Informatics (IMI) is dedicated to research and teaching for the full range of informatics applications in medicine. It was founded in 1973 and belongs to the Medical Faculty. Since 2009 it is headed by Martin Dugas. It provides lectures, seminars and courses in small groups regarding Medical Informatics for medical as well as informatics students. The institute has a long tradition regarding research on information systems in healthcare. The Systematized Nomenclature of Human and Veterinary Medicine (SNOMED), which is now used world-wide in medical information systems, was initiated in Münster more than 30 years ago. Nowadays, the future of information systems in healthcare, specifically for electronic health records (EHRs), is a key research focus. Personalized medicine is built upon clinical and molecular data. Therefore data mining and pattern recognition techniques for genomic data, in particular derived from next-generation sequencing of cancer tissue, is an important research focus.

## RESEARCH TOPICS

The relevance of informatics within all fields of medicine is constantly rising. Medical informatics is an interdisciplinary field with a wide scope of applications. It ranges from molecular biology over clinical medicine to public health.

The integration of clinical and molecular data, especially the analysis of microarray data and high-throughput sequencing in cancer research, is a well-established focus of the institute with national and international cooperations for many years. The rapid increase in data volumes of high-throughput sequencing in molecular medicine poses constant challenges from an informatics point of view. Whereas a gene expression chip provided 10000 data points per patient a few years ago, this number increased to multiple million sequence-reads per patient with modern techniques nowadays.

A major proportion of the data needed for clinical studies is also relevant for routine patient care. Currently, the documentation for studies and patient care are managed in separate systems which results in redundant data input. Hence, a current research topic is the design and efficient implementation of single-source-information systems with integrated documentation. Application fields are electronic health record (EHR) and electronic data capture (EDC) systems.

## CURRENT RESEARCH PROJECTS

### Health Informatics

A portal of medical data models (<http://www.medical-data-models.org>) was designed and implemented by IMI. It contains currently more than 3800 forms and 120000 data elements with semantic codes. IMI is coordinating the pilots for the European project Electronic Health Records for Clinical Research (<http://www.ehr4cr.eu>). EHR4CR is a large-scale initiative with 10 major pharmaceutical companies and 11

university hospitals in 5 countries. The DFG project single source (joint project with Gottfried Vossen) was completed successfully this year. The project mobile patient questionnaires (<http://mopat.uni-muenster.de>) continues and is rolled out to further clinics.

## Biomedical Informatics

Recently a project for improved diagnostics of tumor diseases with new DNA sequencing methods and algorithms (funded by German Cancer Aid foundation) was started. It is a collaborative project with Carsten Müller-Tidow (see Figure 2). Both genomic and epigenomic data will be analyzed.

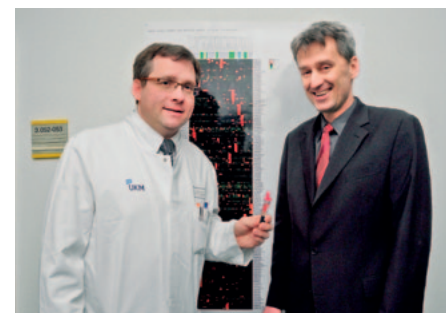

DKH project for improved leukemia diagnostics based on genome sequencing. (Carsten Müller-Tidow (left), Martin Dugas (right))

Several IMI-projects are dedicated to analysis of genomic aberrations in childhood leukemia. The overall goal is to better understand the molecular mechanisms of this disease based upon sophisticated big data analyses. The Leukemia gene atlas (<http://www.leukemia-gene-atlas.org>) was developed by IMI to support integrative data analysis.

## EVENTS

July 2013: 40<sup>th</sup> anniversary of the Institute. An academic event with more than 100 participants, including a speech from Prof. Jörg Becker, Vice-Rector of Münster University and ERCIS director. It was followed by a workshop about past, present and future of medical informatics with internationally renowned keynote speakers.

## PUBLICATIONS

*Schoofs T, Rohde C, Hebestreit K, Klein HU, Göllner S, Schulze I, Lerdrup M, Dietrich N, Agrawal-Singh S, Witten A, Stoll M, Lengfelder E, Hofmann WK, Schlenke P, Büchner T, Hansen K, Berdel WE, Rosenbauer F, Dugas M, Müller-Tidow C.* DNA methylation changes are a late event in Acute Promyelocytic Leukemia and coincide with loss of transcription factor binding. *Blood* 2013;121(1):178–87

*Cai Chen, Christoph Bartenhagen, Michael Gombert, Vera Okpanyi, Vera Binder, Silja Röttgers, Jutta Bradtke, Andrea Teigler-Schlegel, Jochen Harbott, Sebastian Ginzler, Ralf Thiele, Ute Fischer, Martin Dugas, Jijun Hu, Arndt Borkhardt.* Next-generation-sequencing-based risk stratification and identification of new genes involved in structural and sequence variations in near haploid lymphoblastic leukemia. *Genes, Chromosomes and Cancer* 2013; 52:564–579

*D. W. Bates, M. T. Baysari, M. Dugas, W. E. Haefeli, A. W. Kushniruk, C. U. Lehmann, J. Liu, J. Mantas, A. Margolis, K. Miyo, C. Nohr, M. Peleg, F. G. B. de Quirós, S. P. Slight, J. Starmer, K. Takabayashi, J. I. Westbrook.* Discussion of “Attitude of Physicians Towards Automatic Alerting in Computerized Physician Order Entry Systems”. *Methods Inf Med* 2013; 52(2): 109–127

*Köpcke F, Trinczek B, Majeed RW, Schreiweis B, Wenk J, Leusch T, Ganslandt T, Ohmann C, Bergh B, Röhrig R, Dugas M, Prokosch HU.* Evaluation of data completeness in the

electronic health record for the purpose of patient recruitment into clinical trials: a retrospective analysis of element presence. *BMC Med Inform Decis Mak.* 2013 Mar 21;13:37

*Bartenhagen C, Dugas M.* RSVSim: an R/Bioconductor package for the simulation of structural variations. *Bioinformatics* 2013. May 23. PMID: 23620362

*Röhrig R, Stausberg J, Dugas M.* Development of National Competency-based Learning Objectives “Medical Informatics” for Undergraduate Medical Education. *Methods of Information in Medicine* 2013; 52(3): 184–188

*Hebestreit K, Dugas M, Klein H.* Detection of Significantly Differentially Methylated Regions in Targeted Bisulfite Sequencing Data. *Bioinformatics* 2013. June 4. PMID: 23658421

*Dugas M, Fritz F, Krumm R, Breil B.* Automated UMLS-based Comparison of Medical Forms. *PLoS ONE* 2013;8(7): e67883

*Haferlach T, Nagata Y, Grossmann V, Okuno Y, Bacher U, Nagae G, Schnittger S, Sanada M, Kon A, Alpermann T, Yoshida K, Roller A, Nadarajah N, Shiraishi Y, Shiozawa Y, Chiba K, Tanaka H, Koeffler HP, Klein HU, Dugas M, Aburatani H, Kohlmann A, Miyano S, Haferlach C, Kern W, Ogawa S.* Landscape of Genetic Lesions in 944 Patients with Myelodysplastic Syndromes. *Leukemia* 2013 Nov 13. PMID: 24220272



## CONTACT DETAILS

**PROF. DR. MARTIN DUGAS**  
Institute of Medical Informatics

University of Münster  
Albert-Schweitzer-Campus 1/A11,  
48149 Münster, Germany  
P +49 251 83-55262  
<http://imi.uni-muenster.de>  
[dugas@uni-muenster.de](mailto:dugas@uni-muenster.de)

## KEY FACTS

### INSTITUTION

- founded in 1973
- Institute of the Medical Faculty

### RESEARCH TOPICS

- Health Informatics
  - Medical Data Models
  - Electronic Health Records
  - Electronic Data Capture
  - Mobile documentation
- Biomedical Informatics
  - Personalized medicine
  - Next generation sequencing
  - Clinical translation



Participants of the 40<sup>th</sup> anniversary celebration of IMI





## ABOUT THE INSTITUTION

Major objective of the Chair for Information Systems (IS) and Supply Chain Management (SCM), directed by Prof. Dr.-Ing. Bernd Hellingrath, is the development of application-oriented research contributions in the areas of SCM, logistics and operations management with regard to the support by IS. Special focus lies in the development of planning methods to empower today's supply chains (SC) to tackle growing uncertainties, e.g. stemming from more and more fluctuating customer demand, increasing natural or human threats or by unforeseen break downs of resources. In this context, different research projects have been established with other European and international research institutions.

## RESEARCH TOPICS

Overall, the Chair is focusing on a number of different research topics:

**Spare Parts Supply Chain Management (SPSCM):** For maintenance, the prompt availability of required spare parts, equipment and qualified maintenance service personnel at the place of repair is a crucial aspect. The chair's research covers the incorporation of condition monitoring data in improved forecasting methods for spare part demands in order to enable an integrated planning for planning spare part supply chains.

**Innovative optimization techniques for Supply Chain Planning (SCP):** Planning tasks in SCM become increasingly more complex due to numerous factors. Because of this increase in complexity, traditional planning methods are often unable to create good solutions within a suitable time-

frame. Therefore, the chair seeks to assess several methods from computational intelligence regarding their applicability in SCP, determines needed adaptations of these methods and evaluates their effectiveness in comparison to established methods.

**Supply Chain Flexibility (SCF):** Flexibility in supply chains serves as a means to cope with uncertainty. Research of the chair focuses on the questions how well a SC can adapt to changes, how a good balance between flexibility measures and flexibility costs can be determined, and how an efficient combination of flexibility measures to apply can be determined.

**Supply Chain Security (SCS):** Within the last decade, the protection of SC from deliberate attacks and misuse, e.g. the introduction of contraband, has gained large attention. The chair's research focuses on security in business process management, e.g. modeling security aspects and analyzing processes for security issues, and security initiatives and governance in SC.

**Humanitarian Logistics:** The chair conducts research on modeling and performance measurement of a humanitarian supply chain, on the application of methods and tools for information gathering enabling an assessment for the available infrastructure after disaster occurrence, as well as the development and evaluation of software for humanitarian logistics. The research outcomes enable humanitarian organizations to improve their logistics performance and to reduce logistics related costs in disaster relief.

## CURRENT RESEARCH PROJECTS

Currently, the chair is involved in several national and international projects funded by German as well as European and Brazilian institutions:

**[I2MS2C]** (Integrating Intelligent Maintenance Systems and Spare Parts Supply Chains) is related to the chair's research on spare parts supply chains. The project is funded by the German Research Foundation (DFG) and is conducted in cooperation with the Federal University of Santa Catarina, Federal University of Rio Grande do Sul and Federal University Foundation of Rio Grande in Brazil.

**[MetaSCP]** (Application and Extension of Meta-Heuristics for Supply Chain Planning) is a joint project with the Brazilian universities Universidade de Pernambuco and Universidade Federal do Ceará. Funded jointly in the PROBRAL program by the German Academic Exchange Service (DAAD) and by a foundation within the Brazilian ministry of education (CAPES), its major research goal is the adaptation and evaluation of innovative optimization algorithms for complex planning tasks in the context of SCM.

**[MatuFlex]** (Development of a Maturity Measurement Framework for Supply Chain Flexibility) is an additional research project within the PROBRAL program carried out in collaboration with the universities Universidade Federal de Sao Carlos and the Pontifícia Universidade Católica do Rio de Janeiro. It targets the development of a maturity measurement framework for SCF.

**[InPoSec]** (Integrated Postal Security) aims at securing the postal infrastructure and protecting civil security from terrorism and organized crime. The project headed by Prof. Hellingrath is funded by Federal Ministry of Education and Research (BMBWF) and French National Research Agency. Partners in this project are, amongst others, Deutsche Post, La Poste, and Université de Bordeaux.

**[NITIMesr]** (Marie Curie Initial Training Network on Networked Crisis Manage-

ment) is a European Union funded initiative focusing on crisis management. The chair's project part is intended to provide a conceptual and technological SCM system, supporting the design, planning and execution of logistics processes in humanitarian organizations as well as the coordination of capacities and resources within the entire SC.

## AWARDS

The Institute for Studies Brazil Europe (IBE), composed of Brazilian and European universities honored the chair's research project [MetaSCP] with the IBE Award as the 3<sup>rd</sup> best ongoing research project between Brazilian and European universities.

## EVENTS

**[IFAC-Workshop]** In conjunction with Prof. Pereira (Federal University of Rio Grande de Sul), Prof. Hellingrath chaired the special session "Improving the Spare Parts Supply Chain by Intelligent Maintenance Systems" at the 11th IFAC workshop on Intelligent Manufacturing Systems in São Paulo, Brazil. The session addressed the integration of information provided by intelligent maintenance systems into improved planning and coordination methods as well as processes of spare parts supply chains.

**[Humanitarian Logistics Council]** Prof. Hellingrath led the second BVL international's Humanitarian Logistics Council in 2012 and 2013 with the aim to develop solution approaches for a sustainable improvement of Humanitarian Logistics. The results have been presented in a joint publication as well as at BVL's 30<sup>th</sup> International Supply Chain Conference in Berlin.

**[ISCRAM-Workshop]** The chair organized the workshop "GDACSmobile – Mobile Applications and Social Media in Crisis Management" at the 10<sup>th</sup> ISCRAM conference in Baden-Baden. In this workshop the state of the art and future trends of rapid assessment tools have been discussed and "experienced" with a simulation exercise using an assessment application developed at ERCIS.

## PUBLICATIONS

*Böhle, C., Hellingrath, B., Middelhoff, M. and Deuter, P. 2013. "Modeling and Analyzing Secure Business Processes in Logistics" in Proceedings of the Future Security 2013, Berlin, Germany.*

*Espindola, D., Frazzon, E. M., Hellingrath, B. and Pereira, C. E. 2013. "Integrating Intelligent Maintenance Systems and Spare Parts Supply Chains" in 14<sup>th</sup> IFAC Symposium on Information Control Problems in Manufacturing, vol. 14: IFAC, Elsevier, pp. 1017–1022.*

*Hellingrath, B., Böhle, C. and Middelhoff, M. 2013. "Simulation of a Logistics Network to Import Goods with Unknown Risk to Increase the Security in the Supply Chain" in Proceedings of the ASIM 2013, Paderborn, Germany.*

*Hellingrath, B., Link, D. and Widera, A. (eds.) 2013. "Managing Humanitarian Supply Chains: Strategies, Practices and Research" Bremen, Germany: BVL International/DVV Media Group.*

*Link, D., Hellingrath, B. and De Groeve, T. 2013. "Twitter Integration and Content Moderation in GDACSmobile" in Proceedings of the International Conference on Information Systems for Crisis Response and Management (ISCRAM) 2013, Baden-Baden, Germany.*

*Pfeiffer, D., Terlunen, S., Fischer, J.-H. and Hellingrath, B. 2013. "Introducing Supply Chain Segmentation Procedures into Flexibility Management" in Proceedings of the 24<sup>th</sup> Annual Conference of the Production and Operations Management Society, Denver, USA.*

*Terlunen, S., Barreto, G. and Hellingrath, B. 2013. "Application and Evaluation of Multi-criteria Clustering Approaches for Customer-oriented Supply Chain Segmentation" in Proceedings of the LM 2013, Bremen, Germany.*

## DISSERTATIONS

*Küppers, P. 2013. "Coordination in Heterarchical Supply Chains – A Framework for the Design and Evaluation of Collaborative Planning Concepts", Westfälische Wilhelms-Universität Münster, Münster, Germany.*



## CONTACT DETAILS

**PROF. DR.-ING. BERND HELLINGRATH**  
Chair for Information Systems and Supply Chain Management

University of Münster  
Leonardo-Campus 3  
48149 Münster, Germany  
P +49 251 83-38000  
[www.wi.uni-muenster.de/departments/groups/logistik](http://www.wi.uni-muenster.de/departments/groups/logistik)  
[hellingrath@ercis.uni-muenster.de](mailto:hellingrath@ercis.uni-muenster.de)

## KEY FACTS

### INSTITUTION

- 13 Research Assistants
- 1 Postdoc
- 16 Student Assistants

### RESEARCH TOPICS

- Spare Parts Supply Chain Management
- Decentralized Supply Chain Coordination
- Supply Chain Architecture Management
- Supply Chain Segmentation
- Supply Chain Flexibility
- Supply Chain Security
- Humanitarian Logistics
- Computational intelligence methods for Supply Chain Planning



# UNIVERSITY OF MÜNSTER – INSTITUTE FOR INFORMATION-, TELECOMMUNICATION- AND MEDIA LAW (ITM) – CIVIL LAW DEPARTMENT

itm

## ABOUT THE INSTITUTION

The ITM is the leading Institute for Information, Telecommunication and Media Law in Germany. The Institute's work aims at exploring the legal framework and underlying policies of the information society with a particular focus on "information" as an economic and cultural good. The Institute emphasizes the importance of interdisciplinary work since a proper understanding of the technological or economic background is a pre-requirement for successful regulation. Many activities are carried out in close cooperation with the faculty of economics of the University of Münster. In 2002, the ITM was appointed the Competence Centre in Information, Telecommunication and Media Law for North Rhine-Westphalia. Dr. Thomas Hoeren is a professor of civil law at the University of Münster and has been the director of the ITM since 1997. Due to international projects such as CONSENT, LAPSI, TIMBUS, and MonIKA, Prof. Hoeren has become recognised as a specialist in information law throughout Europe.



## RESEARCH TOPICS

Our research focuses on Information Law, Telecommunication Law and Media Law as well as related areas such as Antitrust and Consumer Protection Law. Since Information, Telecommunication and Media law is characterized as a cross-sectional matter, it cannot be fully covered by any of the traditional legal disciplines by itself. The ITM, therefore, strives for interdisciplinary research and teaching activities.

## CURRENT RESEARCH PROJECTS

Currently, the ITM is involved in several EU-funded and national projects.

- **TIMBUS** (Digital Preservation for Timeless Business Processes and Services) is an interdisciplinary research project promoted by the Commission of the European Union and a part of the Seventh Framework Programme for research and technological development (FP7). Project partners are research institutes, NGOs as well as reputable companies (Project Coordination by SAP AG) from Germany, Portugal, Austria, Ireland and Great Britain. The main objective of TIMBUS is to extend the field of application of digital preservation from static data over the

area of holistic and ongoing business processes. TIMBUS will explore the data filtering and data storage format for the activities and mechanisms that are considered necessary for a continuous access, retrieval and validation of current business processes. In the context of Business Continuity Management a new toolkit will be developed. This Legalities Lifecycle Management will present an innovative and comprehensive legal solution for long-term preservation of business processes and will establish the next generation Holistic Escrow Services.

- **CONSENT** (Consumer sentiment regarding privacy on user generated content services in the digital economy) is an interdisciplinary research project on the EU-level. CONSENT aims to examine consumer sentiment regarding privacy on user generated content (UGC) services such as Youtube, Facebook and MySpace in the digital economy.

- **MonIKA** (Monitoring through fusion and classification of information for the detection of anomalies), a project funded by the German Federal Ministry for Education and Research, is conducted in cooperation with partners in the field of science and industry, namely the Fraunhofer-Institut FKIE, the Unabhängige Landeszentrum für Datenschutz Schleswig-Holstein as well as the EADS-associated enterprise Cassidian. As a result, effective procedures for the detection of security relating anomalies in networks and IT-infrastructures shall be developed and established, complying with general legal conditions and Data Protection Law in particular.

- **Within the LAPSI project** (Legal Aspects of Public Sector Information), the involved institutions explore the legal problems regarding Public Sector Information and means of solving them on an international level.

- Moreover, the ITM also hosts the Research Centre for Industrial Property Rights, which offers training and conducts research activities in the field of industrial property rights.

- Moreover, the ITM is part of the German Research Network (Deutsches Forschungszentrum/DFN) that supports communication and the exchange of information between representatives of science, research, education and culture in national and international networks. Increasingly, our DFN-members are being faced with issues regarding legal questions of liability, telecommunications and data protection. Therefore, the ITM appears as a legal consultant in terms of information and communication services.

## DISSERTATIONS

*Dr. Eva-Maria Herring (2013)* Biopatentierung und Sortenschutz: Komplementäres Schutzregime oder konfliktträchtiges Spannungsverhältnis

*Dr. Nadine Kalberg (2013)* Datenschutz an Hochschulen: Eine Analyse der Rechtsgrundlagen und ihrer Umsetzung in integriertem Informationsmanagement und Forschung

*Dr. Sebastian Neuraüter (2013)* Das Bauhaus und die Verwertungsrechte: Eine Untersuchung zur Praxis der Rechteverwertung am Bauhaus 1919–1933

*Dr. Felicitas Rieger (2013)* Ein Leistungsschutzrecht für Presseverleger

*Dr. Patricia Maria Rogosch (2013)* Die Einwilligung im Datenschutzrecht

*Dr. Julia Seiler (2013)* Die rechtliche Bedeutung der Patentregistereintragung unter besonderer Berücksichtigung des Patentverletzungsprozesses

*Dr. Verena Karen Steigert (2013)* Datenschutz bei unternehmensinternen Whistleblowing-Systemen



## CONTACT DETAILS

**PROF. DR. THOMAS HOEREN**  
Institute for Information-, Telecommunication- and Media Law (ITM),  
Civil Law Department

University of Münster  
Leonardo-Campus 9  
48149 Münster  
P +49 251 83-38600  
[www.uni-muenster.de/jura.itm/hoeren](http://www.uni-muenster.de/jura.itm/hoeren)  
[hoeren@uni-muenster.de](mailto:hoeren@uni-muenster.de)

## KEY FACTS

### INSTITUTION

- Founded in 1997
- Researchers: 18
- 3 additional education programs

### RESEARCH TOPICS

- Information Law
- Telecommunication Law
- Media Law
- Informatics in Legal Profession

## Interorganizational Systems Group



### ABOUT THE INSTITUTION

Our research explores the impact of information and communication infrastructures in an organizational context. We are interested in the development of the digital and the social organization: how do organizations and leaders respond to the challenges and opportunities of an informed society and economy. In particular we look at new modes of organizing, coordination and collaboration from the micro level of work practices, to the meso level of group practices and the macro level of infrastructure development.

We aim to understand the dynamics of transformation in a historical, societal, regulatory, and economic context. Our work is theoretically and empirically grounded, we employ multiple methods and research approaches with an emphasis on qualitative, interpretative approaches.

It is our research philosophy that the implications of innovative ICT become visible and understandable in the context of (communities of) practices. In order to study practices in situ, we advocate a Living Laboratory approach which emphasizes research and experimentation in complex real world settings addressing business or societal innovation. Typically multiple stakeholders and researchers from different disciplinary backgrounds are involved.

### RESEARCH TOPICS

We pursue this agenda through three, interrelated fields of research:

1. The **Communication & Collaboration Management** group studies the impact of ICT infrastructures – specifically real-time collaboration (RTC) or social software – on new ways of organizing and work from the individual up to the network level. The emphasis is first on detailed multi method workplace studies in order to gain deep insights into work practices. Secondly we are looking at the organizational “pace” as an indicator of occupational strain. And thirdly we are developing suggestions for organizational development and transformation.

A key theme of our research are the ambivalent outcomes of technology: at the organizational level we observe increasing scope for the design of collaborative and virtual work with performance gains next to increasing multi-tasking, fragmentation of tasks and time pressure with detrimental effects for the organization. At an individual level, the convenience of technological tools is appreciated by employees (up to the point of addictive behavior), the downsides express themselves in terms of increased strain and stress as a result of creeping organizational and behavioral changes (always on).

The Competence Center Smarter Work provides an institutional framework for our research and collaboration with academic partners and industry.

2. The research group on **Strategic Information Management** comprises a team of researchers particularly interested in how management can make effective use of information and communication technology in support of the information age organization. The research group’s current research is in the fields of IT strategy, in organizational benefits of IT investments, and in managing IT operations for reliable services. The research group’s aim is to provide guidance to senior executives by offering recommendations that are both, theoretically well founded and carefully validated in industry practice.

3. The **Interorganizational Systems** group studies the evolution of information infrastructures, such as electronic markets or electronic platforms for the exchange of logistics or health care information, over long periods of time. We take a particular interest in the development and transformation of interorganizational information infrastructures and related theoretical as well methodological questions. Specifically we study

- how to facilitate collective action in heterogeneous actor constellations or coalitions, as the development of infrastructures involves commitment and coordination of diverse actors,
- how standards, which may affect strategic interests, can be developed and widely diffused,
- how industry structures, specifically structures of intermediation, are transformed alongside the proliferation of ICT.

We study these issues in the context of the health care sector, the tourism industry and humanitarian logistics.

### CURRENT RESEARCH PROJECTS

**Interorganizational Information Infrastructures – Structures, Practices and Development Patterns**, funded by the German Science Foundation (DFG)

Interorganizational information infrastructures have become the backbone of modern societies. Still we know little about their role, impact and development across different segments of society. The project studies three initiatives for information infrastructure development in healthcare, electronic prescription, automatic drug dispensing and tracking & tracing in pharmaceutical supply chains. All three initiatives are not only practically relevant they also pose numerous theoretical challenges: the field is highly regulated, there are heterogeneous constellations of individual and collective actors, micro, meso, and macro level developments are interlinked. We have reconstructed the development of electronic prescription and automatic drug dispensing in Germany and compare and contrast the findings with similar initiatives in other European countries. The research design of this exploratory project covers the extension of methods such as ethnographic accounts and participatory observation (practice probes) as well as learning communities. Our main theoretical foundations are infrastructure and practice theory.

### PUBLICATIONS

*Kramer, M., Schallenmüller, S., & Klein, S. (2013).* Drink your own champagne: Analysis of the transformation of a technology provider with Real Time Collaboration from a strategic and organizational point of view. In 26<sup>th</sup> Bled eConference eInnovations: Challenges and Impacts for Individuals, Organizations and Society (1–17). Bled, Slovenia.

*Reimers, K., Johnston, R. B., Guo, X., Klein, S., Xie, B., & Li, M. (2013).* Novice-based Data Collection Methods for the Study of IOIS : Practice Probes and Learning Communities. *Electronic Markets*, Online first, (April). Doi: 10.1007/s12525-013-0126-6

*Reimers, K., Johnston, R. B., & Klein, S. (2013a).* An empirical evaluation of existing IS change theories for the case of IOIS evolution. *European Journal of Information Systems*, advance online publication (22), 127. doi:10.1057/ejis.2013.7

*Reimers, K., Johnston, R. B., & Klein, S. (2013b).* Seeing EMR Emergence through a Practice Lens : Implications for Smaller Healthcare Practices. In *AMCIS 2013 Proceedings* (1–10).

*Schellhammer, S., Haines, R., & Klein, S. (2013).* Investigating Technostress in situ: Understanding the Day and the Life of a Knowledge Worker Using Heart Rate Variability. In *Proceedings of the 46<sup>th</sup> Hawaii International Conference on Systems Sciences (HICSS)*.

*Schellhammer, S., Haines, R. (2013, forthcoming).* Towards contextualizing stressors in technostress research. In: *Proceedings of the 2013 International Conference on Information Systems (ICIS)*, Milan, Italy.

*Schellhammer, S., & Klein, S. (2013).* Walking a Tightrope: Managing Paradoxes and Tensions between Care taking and Efficiency through IT-enabled Organizational Transformation in a Hospital Group. In *Proceedings of the 46<sup>th</sup> Hawaii International Conference on Systems Sciences (HICSS)*.

*Schellhammer, S., Reimers, K., & Klein, S. (2013).* Emergence of Information Infrastructures – A Tale of Two Islands. *International Journal of Biomedical Engineering and Technology*, 11(3), 231–251.

*Teubner, R. A. (2013).* Information Systems Strategy. Theory, Practice, and Challenges for Future Research, In: *Business & Information Systems Engineering*, 5 (4), 243–257.

*Teubner, R. A. & Pellengahr, A. R. (2013).* State of and Perspectives for IS Strategy Research. In: *Becker, J. et al. (eds.): Working Papers, European Research Center for Information Systems*, No. 16, Münster.



### CONTACT DETAILS

**PROF. DR. STEFAN KLEIN**  
Chair for IS and Interorganizational Systems, Department of Information Systems, Münster

University of Münster  
Leonardo-Campus 11  
48149 Münster  
P +49 251 83-38110  
[www.wi.uni-muenster.de/wi](http://www.wi.uni-muenster.de/wi)  
[klein@ercis.uni-muenster.de](mailto:klein@ercis.uni-muenster.de)

### KEY FACTS

#### RESEARCH TOPICS

- Information and Communications Infrastructures
- Strategic Alignment
- IT Value
- Organization Theory of IS
- Transformation of Work
- Appropriation of Communication Infrastructures
- Communities of Practice
- Collective Action and Standardization
- Living Lab Research Approach





## ABOUT THE INSTITUTION

Since 1997, the Chair of Practical Computer Science has been led by Prof. Dr. Herbert Kuchen. He is responsible for teaching in the area of software engineering, programming languages, and programming. Maintaining close partnerships and collaborations with several local companies, we are offering students the chance to write bachelor and master theses with high practical relevance.

## RESEARCH TOPICS

Our research focuses on selected aspects of Software Engineering. Our fields of research are Business Apps, Model Driven Software Development, Domain-Specific Languages, Testing, Parallel Programming, and E-Assessment

## CURRENT RESEARCH PROJECTS

With the increasing importance of mobile devices, mobile applications for business purposes (so called Business Apps) have become a major topic for software vendors and IT-departments of companies. In a joint project with regional companies, we have investigated the status quo of Business App development as well as typical requirements and problems. Based on these findings we pursue several topics that are both relevant for practice and pose research questions. We thereby contribute to the understanding of business app development and deployment. As a particular focus, we explore cross-platform development approaches that handle platform het-

erogeneity. In this regard, we specifically look into model-driven approaches to app development. Our MD framework allows modeling an app in a suitable domain-specific language (DSL) and automatically generates Android and iOS apps from this specification. With basic development taking place in 2012, the framework has been refined and evaluated in the recent year. Work on it will continue.

Domain-specific process modeling languages (DSL) have potential to greatly enhance the efficiency of modeling and the quality of process models. However, developing such DSLs is time-consuming and costly. Moreover, they need to be accompanied by model-to-model transformations, e.g., to the Business Process Model and Notation (BPMN). Therefore, we develop DSLs<sub>4</sub>BPM, a framework for the integrated creation of domain specific process modeling languages and model-to-model transformations.

Practical exercises play an important role in academic teaching. Our E-Assessment system EASy aims to facilitate the management of exercises and supports preparation, conduction, and post-processing of exercises. It is now integrated in the universities e-Learning system Moodle. EASy supports programming tasks, and mathematical proofs as well as verification proofs. Currently, we are developing further modules to support additional types of exercises.

Experience shows that the development of parallel programs is an elaborate and time-consuming task. The Muenster Skeleton Library (Muesli) is a collection of high-level concepts that facilitate the development of parallel programs. The library contains so-called algorithmic skeletons, i.e. frequently recurring parallel programming patterns, which can be easily and efficiently combined to develop parallel applications. Recently, we have extended Muesli for hybrid and heterogeneous architectures and have evaluated simultaneous execution on CPUs and GPUs.

Software testing is essential for the creation of high-quality software. Recently, we have improved the Münster generator of glassbox test cases (Muggl).

## PUBLICATIONS

*Schmitt, O. and Majchrzak, T. A.:* Document-Based Databases for Medical Information Systems and Crisis Management. In: International Journal of Information Systems for Crisis Response and Management (IJIS-CRAM), 5(3): (2013) to appear

*Schulte, M. and Majchrzak, T. A.:* Kontextabhängiges Testen von Apps. In: Testing Experience de, 03, Oktober, Díaz & Hilterscheid Unternehmensberatung GmbH (2013)

*Heitkötter, H. and Majchrzak T. A.:* Cross-Platform Development of Business Apps with MD2. In: Proc. DESRIST 2013, LNCS 7939, Springer, Heidelberg, 405–411 (2013)

*Zibula, A and Majchrzak, T. A.:* Cross-Platform Development Using HTML5, jQuery Mobile, and PhoneGap: Realizing a Smart Meter Application. In: Lecture Notes in Business Information Processing (LNBIP), 140, Springer, 16–33 (2013)

*Heitkötter, H., Hanschke, S. and Majchrzak, T. A.:* Evaluating Cross-Platform Development Approaches for Mobile Applications. In: Lecture Notes in Business Information Processing (LNBIP), 140, Springer, 120–138 (2013)

*Majchrzak T. A. and Heitkötter, H.:* Development of Mobile Applications in Regional Companies: Status Quo and Best Practices. In: Proc. 9<sup>th</sup> International Conference on Web Information Systems and Technologies (WEBIST), SciTePress (2013)

*Heitkötter, H., Majchrzak T. A., Ruland, B. and Weber, T.:* Evaluating Frameworks for Creating Mobile Web Apps. In: Proc. 9<sup>th</sup> International Conference on Web Information Systems and Technologies (WEBIST), SciTePress (2013)

*Heitkötter, H., Majchrzak, T. A., and Kuchen, H.:* Cross-platform model-driven development of mobile applications with MD<sup>2</sup> In: Proc. of the 2011 ACM Symp. on Applied Computing (SAC), ACM, 526–533 (2013)

*Heitkötter, H., Majchrzak, T. A. and Kuchen, H.:* MD2-DSL – eine domänenspezifische Sprache zur Beschreibung und Generierung mobiler Anwendungen. In 6. Arbeitstagung Programmiersprachen (ATPS). Lecture Notes in Informatics (LNI), 215, GI e. V. (2013)

*Ernsting, S., Kuchen, H.:* A Scalable Farm Skeleton for Hybrid Parallel and Distributed Programming. In: International Symposium on High-Level Parallel Programming and Applications (HLPP2013). G. Hains, Y. Khmelevsky, Eds., International Journal of Parallel Programming. Springer Verlag, 2014, to appear.

## DISSERTATIONS

*Heitkötter, H.:* Cross-platform Development of Mobile Business Apps

## EVENTS

Amongst others, Prof. Kuchen served on the program committees of the following conferences:

- Programme committee member of 1<sup>st</sup> International DEXA Workshop on Development of Applications for Next Generation High Performance Systems (DANGHPS 2013), Prague, Czech Republic.

- Programme committee member of 22<sup>nd</sup> International Workshop on Functional and (Constraint) Logic Programming (WFLP 2013), Kiel, Germany.
- Programme committee member of INFOCOMP 2013, Lisbon, Portugal.
- Programme committee member of 27<sup>th</sup> International Workshop on Logic Programming (WFL 2013), Kiel, Germany.
- Programme committee member of International Conference on Parallel Computing (ParCo 2013), München, Germany.

Moreover, he was:

- Member of the Scientific Advisory Board of IMDEA-Software (Research Institute on Technologies for Software Development), Spain.
- Managing Director of the Institute for Applied Informatics at the University of Münster.
- Editor of the Open Journal of Web Technologies

Dr. Majchrzak served on the program committees of the following conferences:

- Web Technologies track of the ACM 28<sup>th</sup> Symposium On Applied Computing (SAC) 2013
- Information Systems Education & Curricula Workshop (ISEC) of the Federated Conference on Computer Science and Information Systems (FedCSIS) 2013

Moreover, he was:

- Member of the Editorial Board of the Open Journal of Information Systems (OJIS)
- Co-Chair of the Special Session on Business Apps (BA 2013) in conjunction with the 9<sup>th</sup> International Conference on Web Information Systems and Technologies (WEBIST 2013)

Additionally, he spent an invited research and teaching collaboration visit at the Universidade de São Paulo, Escola de Artes, Ciências e Humanidades (USP EACH), São Paulo, Brazil.



## CONTACT DETAILS

**PROF. DR. HERBERT KUCHEN**  
Chair for Practical Computer Science

University of Münster  
Leonardo-Campus 3  
48149 Münster, Germany  
P +49 251 83-38250  
[www.wi.uni-muenster.de/pi](http://www.wi.uni-muenster.de/pi)  
[sek-pi@wi.uni-muenster.de](mailto:sek-pi@wi.uni-muenster.de)

## KEY FACTS

### INSTITUTION

- Founded in 1997
- Researchers: 6

### RESEARCH TOPICS

- Business Apps
- Model Driven Software Development
- Parallel Programming
- Software Testing
- Integration of Programming Paradigms
- E-Learning

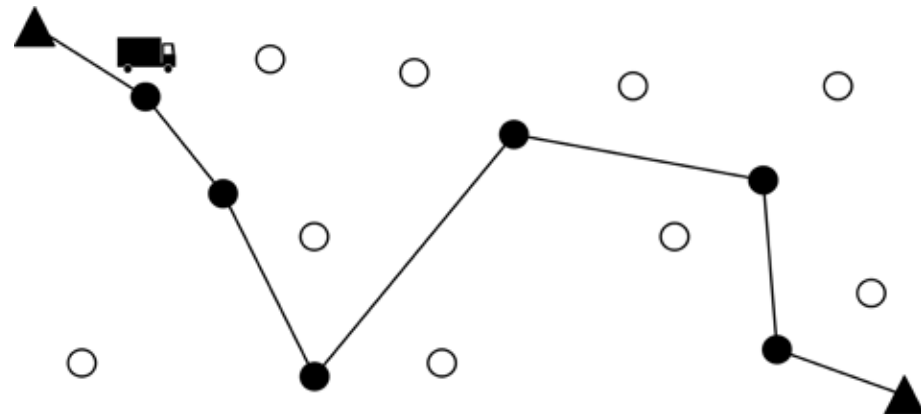

## ABOUT THE INSTITUTION

Quantitative Methods for Logistics is a newly founded group in the Department of Information Systems at the University of Münster, Germany. It has been a member of the European Research Center for Information Systems since June 2013.

The group's activities in both research and teaching primarily focus on optimal decision making within the broad fields of logistics, transportation and business networks. Recently business operations within these fields have been subject to major challenges such as increasing resource prices, electronic commerce, mobile communication as well as real-time tracking and tracing.

The Quantitative Methods for Logistics Group addresses these challenges by developing new models and methods that allow for best possible decision making in today's logistics operations.

As a natural counterpart of the complexity of modern decision processes in logistics, both the models and the methods developed to capture these processes need to rely on a number of different scientific disciplines. Consequently the activities of the group are highly interdisciplinary – combining and integrating techniques from fields such as mathematical optimization, data mining, computer simulation, stochastic processes and databases.

The group is headed by Stephan Meisel, who was a postdoctoral research associate at Princeton University before joining the University of Münster in the summer of 2013. Stephan Meisel currently is an assistant professor at the Department of Information Systems.

## RESEARCH TOPICS

The research activities of the group pursue two main goals. On the one hand the focus is on modeling newly occurring decision problems in logistics and solving these problems by application of recently developed state-of-the-art methods. On the other hand the group's research also aims at advancing the algorithmic state-of-the-art by developing new methods that enable more efficient decision making.

As a response to the needs of today's logistics processes, many current research activities of the group revolve around the area of Anticipatory Optimization for Dynamic Decision Making. Anticipatory Optimization for Dynamic Decision Making may be considered as a general framework that has been established for studying multistage decision problems under uncertainty.

Uncertainty has become one of the main characteristics of real-world logistics processes. New developments such as e-commerce, mass customization and the increasing importance of customer service create situations in which companies continuously receive new information in terms of, e.g., customer orders or service requests. Due to technological innovations such as GPS and mobile communication, companies can use this newly arriving information to repeatedly decide on revision of their current operational plans.

However, any plan revision that is made now does affect the future evolution of the logistics process under consideration. Therefore coordination of re-planning decisions over time becomes the crucial point in managing a logistics process. Anticipatory Optimization takes into account the decision maker's uncertainty about the future and aims at an optimal sequence of re-planning decisions within a given logistics process.

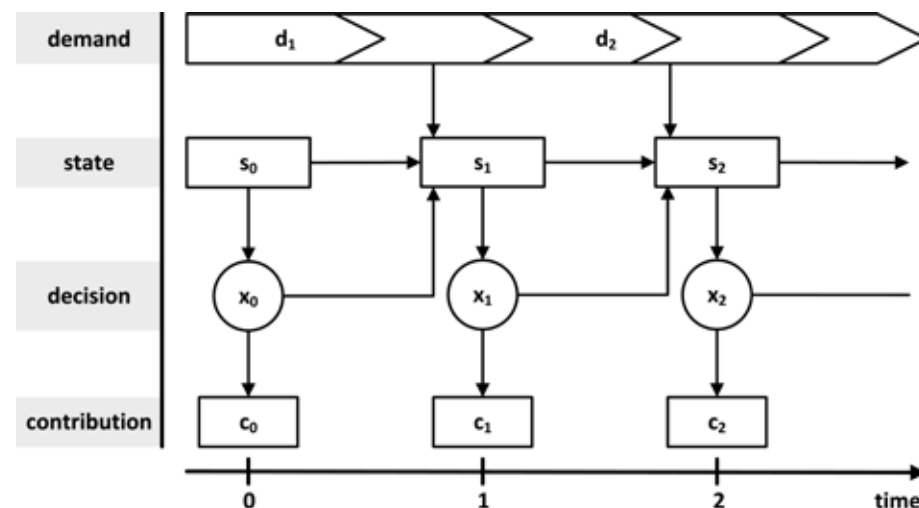

Dynamic Decision Making

## CURRENT RESEARCH PROJECTS

Most of the current research projects focus on a multistage decision problem within a specific application domain. Examples include dynamic supply truck routing in automobile plants, aircraft fleet maintenance or bike relocation in bike sharing systems. Two of the current main projects are:

### Dynamic Service Vehicle Routing

Service vehicles play an important role in a large number of different business models. Grocery shopping home delivery, less-than-truckload trucking and on-site repair and maintenance services are just a few examples. In each of these examples a company running a fleet of service vehicles aims at either minimization of operational costs or maximization of customer satisfaction. In order to achieve these goals, the company has to make repeated decisions on the assignment of customers to vehicles and on the single vehicles routing plans. Each time a new customer calls in both the current customer assignments and routing plans need to be revised.

The main research question is how to do plan revisions such that the decision maker's goal is achieved at the end of the day.

### Energy Storage Management

Energy storage management has become an increasingly important topic in the context of renewable energies. Sources of renewable energy, such as wind or solar, are intermittent and energy prices tend to be varying over time. Therefore companies that rely on renewable energy and that face varying energy prices resort to energy storage devices.

The main research question is how to make repeated decisions about how much energy to store and how much energy to buy from the grid.

The Quantitative Methods for Logistics Group does research on energy storage management in close cooperation with both Princeton University and Professor Ricardo Collado, whose group is part of our ERCIS partner department at Stevens Institute of Technology in Hoboken, NJ.

## PUBLICATIONS

*J. Ehmke, S. Meisel, D. Mattfeld (2012): Floating Car Based Travel Times for City Logistics. Transportation Research Part C: Emerging Technologies, 21(1), 338–352*

*S. Meisel (2011): "Anticipatory Optimization for Dynamic Decision Making"; Operations Research/Computer Science Interfaces Vol. 51; Springer; New York*

*U. Suppa, S. Meisel, D. Mattfeld (2011): "Serving Multiple Urban Areas with Stochastic Customer Requests"; In Kreowski, H.-J., Scholz-Reiter, B., & Thoben, K.-D. (Eds.), Dynamics in Logistics (pp. 59–68); Springer Verlag; Heidelberg*

*U. Suppa, S. Meisel, D. Mattfeld (2011): "GRASP based Vehicle Routing for After Sales Services"; In Proceedings of the Metaheuristics International Conference 2011*

*S. Meisel, D. Mattfeld (2010): "Synergies of Operations Research and Data Mining" European Journal of Operational Research, 206(1), 1–10*

*J. Branke, S. Meisel, C. Schmidt (2008): „Simulated Annealing in the Presence of Noise"; Journal of Heuristics, 14(6), 627–654*



## CONTACT DETAILS

**PROF. DR. STEPHAN MEISEL**  
Department of Information Systems

University of Münster  
Leonardo-Campus 3  
48149 Münster, Germany  
P +49 251 83-38040  
[www.wi.uni-muenster.de/qml](http://www.wi.uni-muenster.de/qml)  
[stephan.meisel@uni-muenster.de](mailto:stephan.meisel@uni-muenster.de)

## KEY FACTS

### RESEARCH TOPICS

- Transportation and Logistics
- Energy Systems
- Resource Allocation Problems
- Dynamic Decision Making
- Anticipatory Optimization
- Computational Stochastic Optimization
- Approximate Dynamic Programming
- Simulation Optimization





## ABOUT THE INSTITUTION

Organizations are increasingly relying on information technology to support communication and collaboration among their employees. This is caused by a growing amount of distributed tasks, the need for expert knowledge, and project-based work. At the same time, the use of public social media (e.g., Twitter and Facebook) and mobile services has tremendously influenced today's society and therefore strongly affects organizations.

The ERCIS Research Group for Communication and Collaboration Management at the University of Münster, headed by Prof. Dr. Stefan Stieglitz, investigates organizational, social, and economic impacts of those massive changes of the organizational environment. The research group, now consisting of five research assistants and 10 student assistants, experienced a very busy, exciting, and great year 2013.

In 2013, we successfully completed a project that was funded by the LWL Kulturstiftung. Results were presented at CEBIT in Hannover. In cooperation with the regional association of Westphalia-Lippe (LWL), the state museum for art and art history has been reconstructed within the virtual 3D-world Unity 3D. The project "Museum 2.0 – Collaboration in Virtual Environments" enables users to enter the museum ubiquitously. The aim of the two-years project (2011–2013) was to investigate virtual worlds as communication and collaboration environments.

Moreover, we successfully completed a project that was funded by the Vodafone Institute for Society and Communication

and the Konrad-Adenauer-Stiftung. The goal of the project was to collect and analyse social media data that was created previously to the federal elections in Germany. Overall we gathered millions of tweets and thousands of blog entries. Based on this data we investigated the impact of certain topics (such as the NSA scandal, the Elbe flooding or tax affairs) on political communication in social media.



CeBIT project team with Svenja Schulze (Minister of Innovation, Science and Research)

In 2013, the research group published more than 23 research articles in journals and conference proceedings. Among others, papers were published in *Journal of Management Information Systems (JMIS)*, *Information, Communication – Society (ICS)*, and *International Journal of Research Methodology (IJRM)*.

Besides this, the research group organized the WWU Münster Social Media Barcamp for the third time (see page 97); and launched the competition: Mobile Apps on Campus.

Furthermore, Stefan Stieglitz and colleagues from TU Berlin, TU Braunschweig, and Jacobs University Bremen founded the Competence Center Connected Organization (see page 76).

## RESEARCH TOPICS

The research group focuses on four research fields:

### Social Media Analytics

It is becoming increasingly important for enterprises and other organizations (particularly political organizations) to recognize relevant issues in social media as early as possible. For this reason, it can be helpful to apply network analysis or methods of text mining on big social media data sets.

### Enterprise Social Networking

Communication in social networks is based on voluntariness and openness (Web 2.0 paradigm). However, the introduction and operation of social software can also be understood as a project, which requires transformation and management activities. Empirical studies are needed to investigate the contradictory contexts of voluntariness and organizational hierarchies.

### Blended Learning

The establishment of social media, mobile devices, and other communication and collaboration systems results in new potentials for teachers, learners, and educational institutions. This becomes apparent by the growing relevance of Massive Open Online Course (MOOC). In this area, we examine the influence of new technologies on knowledge transfer and collaborative learning.

### Mobile Services / Mobile Enterprise

In recent years, smartphones and tablets became widely used mobile devices. This offers new potential for organizations and significantly influences the society (e.g. Work-Life Integration). The research group investigates how mobile services such as mobile applications might enable business values in enterprises and how decision makers can efficiently manage the transformation process.

## CURRENT RESEARCH PROJECTS

### Dynamics of Issues in Twitter

Currently we are working on a project that is funded by the German Research Association (DFG). One goal of the project is to find patterns in the evolution of different types of topics in Twitter communication. In cooperation with our partners from Ludwig-Maximilians-University Munich (Prof. Neuberger) we apply network analysis and text mining on social media data. The project will run from August 2012 until July 2015.

### Discourse Analysis in Social Media

In this interdisciplinary research project, funded by the BMBF, four German universities cooperate to investigate and develop new methods of social media analytics and eHumanities. One major goal is to combine the time-consuming manual content analysis with methods of automatic text analysis (e.g. sentiment analysis, opinion mining, text classification). Therefore, content of Facebook, Twitter, and blogs will be tracked and analyzed on a large scale. Besides Stefan Stieglitz as a researcher in information systems, scholars of communication studies (Profs. Neuberger and Quandt) as well as computer linguistics (Prof. Stede) are involved as principal investigators. (Web: [www.social-media-analytics.org/](http://www.social-media-analytics.org/))

### Visit us on Facebook, Twitter, and Youtube!

Facebook: [www.facebook.com/wikuk](http://www.facebook.com/wikuk)

Twitter: [www.twitter.com/wikuk](http://www.twitter.com/wikuk)

Youtube: [www.youtube.com/wikukunims](http://www.youtube.com/wikukunims)

## EVENTS

- Workshop on "Social Media and Mobile Applications in Enterprises". 27<sup>th</sup> IEEE International Conference on Advanced Information Networking and Applications, Barcelona, Spain.
- Mini track on "Mobile Enterprise" and mini track on "Social Media Analytics". Americas Conference on Information Systems, Chicago, USA.
- Workshop on "Virtual Worlds and Gaming". Informatik 2013, Koblenz, Germany.
- WWU BarCamp 2013, LWL Münster (see page 97)
- Mobile Campus: Competition of ideas

## PUBLICATIONS

Bruns, A., & Stieglitz, S. (2013). Towards More Systematic Twitter Analysis: Metrics for Tweeting Activities. *International Journal of Social Research Methodology*, 16(2), 91–108.

Stieglitz, S., & Dang-Xuan, L. (2013). Emotions and Information Diffusion in Social Media – Sentiment of Microblogs and Sharing Behavior. *Journal of Management Information Systems*, 29(4), 217–248.

Steiner, M., Götz, O., & Stieglitz, S. (2013). The Influence of Learning Management System Components on Learners' Motivation in a Large-Scale Social Learning Environment. In *Proceedings of the International Conference on Information Systems (ICIS)*, Milan, Italy.

Stieglitz, S., & Brockmann, T. (2013). The Impact of Smartphones on E-Participation. In *Proceedings of the 46<sup>th</sup> Hawaii International Conference on System Sciences (HICSS)*, Hawaii, Maui, 1734–1743.

Bögel, S., Stieglitz, S., & Meske, C. (2013). Bringing together BPM and Social Software. In *Proceedings of the 19<sup>th</sup> Americas Conference on Information Systems (AMCIS)*, Chicago, USA.

Meske, C., & Stieglitz, S. (2013). Responsibilities and Challenges of Social Media Managers. In *Proceedings of the 15<sup>th</sup> International Conference, HCI International 2013*, Las Vegas, USA, 342–351.

Krüger, N., Brockmann, T., & Stieglitz, S. (2013). A Framework for Enterprise Social Media Guidelines. In *Proceedings of the 19<sup>th</sup> Americas Conference on Information Systems (AMCIS)*, Chicago, USA.

## DISSERTATIONS

Dang-Xuan, L.: Social Media Adoption, Use, and Analytics



## CONTACT DETAILS

PROF. DR. STEFAN STIEGLITZ  
Research Group for Communication and Collaboration Management

University of Münster  
Leonardo-Campus 11  
48149 Münster, Germany  
P +49 251 83-38115  
[www.wi.uni-muenster.de/kuk](http://www.wi.uni-muenster.de/kuk)  
[stefan.stieglitz@ercis.de](mailto:stefan.stieglitz@ercis.de)

## KEY FACTS

### INSTITUTION

- Founded in April 2010
- 5 Researchers
- Joint projects with partners from industry – Competence Center Connected Organization

### RESEARCH TOPICS

- Enterprise Social Networking
- Community Engineering
- Social Media Monitoring and Analytics
- Collaboration in Virtual Worlds
- Blended Learning
- Mobile Enterprise







## ABOUT THE INSTITUTION

The Information Systems and Statistics group was founded in April 2013 and partly emerged from the Quantitative Methods Group. Since April, Heike Trautmann is head of the group and a new directorate member of ERCIS. Currently, five post-doctoral researchers and one post-graduate researcher are part of the team. The team contributes to the research areas of multiobjective optimization, evolutionary computation, algorithm evaluation and selection, computer games as well as statistical quality management, data retrieval, and clustering techniques in several international collaborations. Additionally, the group offers many courses in Bachelor and Master Degree programs with mathematical, statistical, and algorithmic focus. Besides basic and advanced courses in mathematics, students are provided with statistical background and algorithmic knowledge from operations research. Master courses on data analytics theory and application as well as on statistical quality management deepen students' insight into statistical methods, techniques, and applications.

## RESEARCH TOPICS

*Multiobjective Optimization* deals with the simultaneous optimization of (at least partially) contradicting objectives. We usually focus on the a posteriori case, where an optimization technique offers a set of Pareto-optimal solutions from which a decision maker can pick a subset afterwards. As most of the multi-objective problems cannot be solved exactly, we apply optimization techniques from Evolutionary Computation.

In the context of *Algorithm Benchmarking* activities, the group evaluates the performance of different evolutionary and nature inspired-techniques and contributes to algorithm development and enhancement. For multiobjective evolutionary techniques, the development of quality indicators is a major research topic. Measures for approximation quality with respect to precision and spread of reached solution sets are investigated and included into new algorithmic approaches. Directly related to benchmarking and the identification of characteristics of optimization problems, *Algorithm Selection* means the selection process of suitable algorithmic approaches. Methodologically, identified problem properties are matched to known algorithms' solving characteristics in order to find the best performing approaches for a given problem. Due to cooperation with German and international researchers, the group is strongly involved in this area. For practical applicability of evolutionary multiobjective techniques, the usability of algorithmic approaches and inclusion of additional knowledge (e.g. specific expert knowledge on real world problems) is a major challenge. Therefore, the group develops and evaluates new algorithm architectures and hybridization principles with a user-centric perspective. Computational Intelligence methods are also well suited to *Computer Game AI* problems because they can deal well with partial information, uncertainties, and real-time conditions. We are currently mainly dealing with two hot topics in Game AI, namely non-player character control (in the widest sense, up to developing car racing

controllers or improving team dynamics), and procedural content generation, with a focus on real-time strategy games. Additionally, we also take "non-leisure" games into account and employ current Game AI techniques for Gamification and Serious Games. Whereas the former usually transforms an existing process with human interaction into a game-like situation, the latter means to pursue educational or training purposes.

Furthermore, we are interested in *statistical quality control*. In this area, e.g. the concept of control charts is used for monitoring properties of production processes and testing for significant deviations from specifications.

## CURRENT RESEARCH PROJECTS

The DFG funded cooperation project "Addressing Current Challenges in Evolutionary Multi-Objective Optimization: Indicator-based Selection, Convergence, and Applicability" together with the Laboratório de Inteligência e Robótica Aplicada at Rio de Janeiro University, Brasil, fosters trans-atlantic collaboration in one of the major research topics of the group, namely indicator-based multiobjective evolutionary optimization.

The DFG and DAAD funded collaboration project "Multicriteria Optimization based on Averaging Hausdorff measures" together with TU Dortmund University and CINVESTAV-IPN, Mexico, intensifies research in theoretical evolutionary multiobjective optimization.

The COSEAL (configuration and selection of algorithms) research group (<http://code.google.com/p/coseal/>) is an international consortium of researchers from Canada, Ireland, Denmark and Germany which addresses current challenges from Algorithm Selection, Algorithm Configuration and Machine Learning.

The "sOptimo" project dealt with structural optimization of energy supply systems at industrial locations. Next to several industrial partners, the consortium contained the RWTH Aachen and the Gfal (Gesellschaft für angewandte Informatik) in Berlin. It has been funded by the BMFT and ran until August 2013.

## AWARDS

*M. Preuss*: Winner of the 2013 IEEE CEC Competition on Niching Methods for Multimodal Optimization, <http://goanna.cs.rmit.edu.au/~xiaodong/cec13-niching/competition/>

## EVENTS

In July, the Information Systems and Statistics group organized the 1<sup>st</sup> Workshop on Configuration and Selection of Algorithms (COSEAL) 2013 in Münster. Participants were researchers from Germany, Denmark, Ireland and Canada.

## PUBLICATIONS

*O. Mersmann, B. Bischl, H. Trautmann, M. Wagner, J. Bossek, F. Neumann*: A Novel Feature-Based Approach to Characterize Algorithm Performance for the Traveling Salesman Problem, in: *Annals of Mathematics and Artificial Intelligence*

*O. Mersmann, M. Preuss, H. Trautmann, B. Bischl, C. Weihs*: Analyzing the BBOB Results by Means of Benchmarking Concepts, in: *Evolutionary Computation Journal*

*H. Trautmann, T. Wagner, D. Biermann, C. Weihs*: Indicator-Based Selection in Evolutionary Multiobjective Optimization Algorithms Based on the Desirability Index. *Journal of Multi-Criteria Decision Analysis*

*C. Domínguez-Medina, G. Rudolph, O. Schütze, H. Trautmann*: Evenly spaced Pareto fronts of quad-objective problems using PSA partitioning technique, in: *IEEE CEC 2013*

*M. Preuss, D. Kozakowski, J. Hagelbäck, H. Trautmann*: Reactive strategy choice in StarCraft by means of Fuzzy Control, in: *CIG 2013*

*T. Wagner, H. Trautmann, D. Brockhoff*: Preference Articulation by Means of the R2 Indicator, in: *EMO 2013*

*V. A. Sosa Hernández, O. Schütze, G. Rudolph, and H. Trautmann*: The Directed Search Method for Pareto Front Approximations with Maximum Dominated Hypervolume, in: *EVOLVE 2013*

*H. Trautmann, T. Wagner, D. Brockhoff*: R2-EMOA: Focused Multiobjective Search Using R2-Indicator-Based Selection, in *LION 2013*

*S. Nallaperuma, M. Wagner, F. Neumann, B. Bischl, O. Mersmann, H. Trautmann*: A Feature-Based Comparison of Local Search and the Christofides Algorithm for the Travelling Salesperson Problem, in: *FOGA 2013*  
*C. Grimme, J. Lepping, U. Schwiegelshohn*: Multi-criteria scheduling: an agent-based approach for expert knowledge integration, in: *J. Scheduling 16(4)*, 2013

*I. Terveer*: *Mathematik für Wirtschaftswissenschaften* (3rd ed.), UVK-Lucius, 2013

*N. Büchel, K. F. Hildebrand, U. Müller-Funk*: Factor Preselection and Multiple Measures of Dependence. Algorithms from and for *Nature and Life 2013*

*J. Togelius, M. Preuss, N. Beume, S. Wessing, J. Hagelbäck, G. N. Yannakakis, C. Grappiolo*: Controllable procedural map generation via multiobjective evolution, in: *GENP 14(2)*, 2013

*S. Wessing, M. Preuss, G. Rudolph*: Niching by multiobjectivization with neighbor information: Trade-offs and benefits, in: *IEEE CEC 2013*

*M. Kuchem, M. Preuss, G. Rudolph*: Multi-objective assessment of pre-optimized build orders exemplified for StarCraft 2, in: *CIG 2013*

*M. Preuss, S. Wessing*: Measuring Multimodal Optimization Solution Sets with a View to Multiobjective Techniques. In *EVOLVE 2013*.

## MASTER THESES, DISSERTATIONS, HABILITATIONS

*K. F. Hildebrand*: Model Selection in Information Systems: Electronic Markets and Data Analysis, Dissertation, WWU Münster

*A. Baumgart*: Cluster Stability: Concepts and Determinants, Dissertation, WWU Münster

*M. Preuss*: Multimodal Optimization by Means of Evolutionary Algorithms, Dissertation, TU Dortmund

*P. Kerschke*: Algorithm Selection of Continuous Black-Box Optimization Problems Based on Cost-Sensitive Learning and Explorative Landscape Analysis, Master Thesis, TU Dortmund

*C. von den Driesch*: Semantic Retrieval of Domain-specific Documents, Master Thesis, WWU Münster



## CONTACT DETAILS

**PROF. DR. HEIKE TRAUTMANN**  
Information Systems and Statistics

University of Münster  
Leonardo-Campus 3  
48149 Münster, Germany  
P +49 251 83-38200  
[www.wi.uni-muenster.de/department/groups/statistik](http://www.wi.uni-muenster.de/department/groups/statistik)  
[trautmann@wi.uni-muenster.de](mailto:trautmann@wi.uni-muenster.de)

## KEY FACTS

### INSTITUTION

- Launched in April 2013
- 7 Researchers

### RESEARCH TOPICS

- Multiobjective Optimization
- Evolutionary Computation
- Algorithm Benchmarking
- Algorithm Selection
- Computer Games: Gamification and Serious Games
- Hybridization of Algorithms
- Statistical Quality Management
- Model Selection
- Clustering

### OUTLOOK

August 26–29, 2014, Dortmund, IEEE Conference on Computational Intelligence and Games, [www.cig2014.de](http://www.cig2014.de)





## ABOUT THE INSTITUTION

The Chair of Computer Science at the Department of Information Systems of the University of Münster (Münster, Germany) is part of the ERCIS Headquarters.

Prof. Dr. Gottfried Vossen, head of the Chair, is a Fellow of the German Computer Science Society (GI), Honorary Professor at the University of Waikato Management School (Hamilton, New Zealand), and the European Editor-in-Chief of Information Systems, an International Journal. Prof. Vossen is also an Associate Editor of the International Journal on Semantic Web and Information Systems, GI contact person at the University of Münster, as well as speaker of the local GI chapter. Furthermore, he is a deputy chairman of the steering committee of the German information technology certification agency Cert-IT, Editor-in-Chief of the dissertation series Databases and Information Systems (DISDBIS) published by aka Verlag, as well as a member of several editorial boards and program committees.

## RESEARCH TOPICS

The areas of research interest at the Chair include the challenges related to data and processes, such as data warehousing, (social) business process management, big data processing and handling, data marketplaces, data pricing, information provisioning, and specific modern applications involving social media.

## CURRENT RESEARCH PROJECTS

The Databases and Information Systems Group (DBIS Group) in close cooperation with the University of Waikato Management School, which is a member of the ERCIS network in New Zealand, conduct a research project Web in Your Pocket (WiPo). The project concept was originally developed by Stuart Dillon (University of Waikato), Florian Stahl (DBIS Group), and Gottfried Vossen (DBIS Group). It is based on the observation that even though the Web offers a plethora of data and information, highly specialized or complex search queries – such as queries regarding rare illnesses or a comprehensive holiday-itinerary – still cannot be answered by common search engines in a satisfying way. The WiPo approach differs from traditional search engines in a way that it exploits comprehensive (pre-)processing of Web data and includes curation – a partially manual supervision of data sources and data quality with regard to a given subject area. Furthermore, “in your pocket” refers to the fact that parts of the information gathered in this way shall be made available offline on a portable device in order to allow users to access the information even when mobile Internet connection is not available or too expensive.

In order to achieve delivery of more valuable search results, it is important to tailor a query response to a user’s informational needs. Consequently, users will need to provide WiPo with their preferences and prior knowledge. Based on this information, Web-crawling, data mining, and data curation techniques will be used to generate search results, which satisfy more advanced information needs.

For example, imagine a tourist planning a trip to remote areas in New Zealand. A simple Web search would lead to numerous results, which are not easily comparable. It would require a lot of time and efforts to compile a list of personalized sights, even if only the first 20 results would be considered. WiPo addresses the phenomenon of information overload by condensing the magnitude of information available through filtering and enhancing relevant content.



At the beginning of 2013 Prof. Vossen and Florian Stahl visited Stuart Dillon und Karyn Rastrick at the University of Waikato Management School to work on the project concept, which was then documented in several publications. At the moment the concept is being turned into a first prototype, which is planned to be released for extensive testing in both Germany and New Zealand at the beginning of 2014.

A second major research project is the Big Data Lab, a testbed especially targeting small and medium enterprises (SMEs). In this lab, which is accessible at <http://lab.uni-muenster.de/>, SMEs are able to gain hands-on experience with Big Data technologies in the context of realistic business cases.

## AWARDS

The “Book of the Future” project conducted by the DBIS Group won the 2013 Digital Publishing Creative Ideas Contest, a competition organized by Goethe Unibator, the incubator of Goethe University Frankfurt. The evaluation criteria included innovative usage of existing technologies, sustainable business model, and impact on industry and society. “Book of the Future” is a content-centric e-Book and Web application for students.

## EVENTS

4<sup>th</sup> December, 2013 the Finale of the 6<sup>th</sup> ERCIS Launch Pad will be held. ERCIS Launch Pad is a creative start-up idea contest organized by ERCIS. Shortlisted teams will present their ideas to a jury of experts from industry and academia. Moreover, former winners and successful founders will report on their experiences.

## PUBLICATIONS

*P. Childerhouse, W. Luo, Ch. Basnet, H.J. Ahn, H. Lee, G. Vossen (2013): Evolution of Inter-Firm Relationships: A Study of Supplier-Logistical Services Provider-Customer Triads; International Journal of Industrial Engineering 20 (1 – 2) 2013, 126–140*

*G. Graefe, A. Nica, K. Stolze, T. Neumann, T. Eavis, I. Petrov, E. Pourabbas, D. Fekete (2013): Elasticity in Cloud Databases and Their Query Processing. International Journal of Data Warehousing and Mining (IJDW), 9(2), 1–20*

*T. Haselmann, G. Vossen (2013): Hybrid Cloud Intermediaries – Facilitating Cloud Sourcing for Small and Medium-sized Enterprises; Proc. 3<sup>rd</sup> International Conference on Cloud Computing and Services Science (CLOSER) 2013, Aachen, Germany*

*T. Haselmann, G. Vossen (2013): EVACS: Economic Value Assessment of Cloud Sourcing by Small and Medium-sized Enterprises; Proc. CloudAsia 2013, Cloud Research and Innovation Track, Singapore, May 2013*

*T. Haselmann, G. Vossen (2013): Data Streaming im Verkehr; in I. Pies (Hrsg.): Das weite Feld der Ökonomik: Von der Wirtschaftsforschung und Wirtschaftspolitik bis zur Politischen Ökonomik und Wirtschaftsethik; Schriften zu Ordnungsfragen der Wirtschaft Band 98, Lucius & Lucius, Stuttgart, 2013, 111–123*

*N. Pflanzl, G. Vossen (2013): Human-Oriented Challenges of Social BPM; Proc. 5<sup>th</sup> International Workshop on Enterprise Modelling and Information Systems Architectures (EMISA) 2013, St. Gallen, Switzerland, GI-Edition LNI P-222, 163–176*

*F. Schomm, F. Stahl, G. Vossen (2013): Marketplaces for Data: An Initial Survey; ACM SIGMOD Record 42 (1), 2013, 15–26*

*F. Schomm, G. Vossen (2013): Mobile-Device-Management im Zeitalter von IT Consumerization; DOAG Business News, Ausgabe Sommer 2013, 27–29*

*F. Schomm, F. Stahl, G. Vossen (2013): The Data Marketplace Survey Revisited; Working Paper No. 135, European Research Center for Information Systems, November 2013*

*F. Stahl (2013): High Quality Information Provisioning and Data Pricing; ICDE 2013 PhD Symposium Paper, Brisbane, Australien*

*G. Vossen (2013): Model Engineering as a Social Activity: The Case of Business Processes; Proc. 3<sup>rd</sup> International Conference on Model & Data Engineering (MEDI) 2013, Amantea, Italy, Springer LNCS 8216, 2013, 264–265*

*St. Dillon, F. Stahl, G. Vossen, K. Rastrick (2013): A Contemporary Approach to Coping with Modern Information Overload; to appear in Communications of the ICISA: An International Journal*



## CONTACT DETAILS

**PROF. DR. GOTTFRIED VOSSEN**  
Chair of Computer Science

University of Münster  
Leonardo-Campus 3  
48149 Münster, Germany  
P +49 251 83-38150  
<https://www.wi.uni-muenster.de/department/groups/dbis>  
vossen@uni-muenster.de

## KEY FACTS

### RESEARCH TOPICS

- (Social) Business Process Management
- Big Data Processing and Handling
- Data Marketplaces and Pricing
- Data Warehousing
- Information Provisioning (Web in your Pocket)
- Modern Applications Involving Social Media

### EVENTS

- ERCIS Launch Pad (annually)



# KEDGE BUSINESS SCHOOL – DEPARTMENT OPERATIONS MANAGEMENT AND INFORMATION SYSTEMS

**KEDGE**  
BUSINESS SCHOOL

## ABOUT THE INSTITUTION

Kedge Business School Bordeaux Campus Kedge Business School offers a large portfolio of degree programs ranging from bachelor's and master's degrees to MBAs and Executive Education. Research performed by its faculty is highly regarded, and covers such areas as global responsibility, supply chain management, wine and spirits management, arts & culture management and innovation in SME. International students can also take a semester abroad in one of its 280 partner universities.

Kedge Business School holds three accreditations – from EQUIS, AACSB and AMBA – and has been ranked by the Financial Times since 2008. Kedge Business School committed to excellence, social responsibility and diversity. Therefore, it has decided to offer financial support to talented international students.

The "Operations Management and Information Systems" department is valued for its competency in purchasing, logistics, supply chain and information systems management. The team members are highly recognized for expertise in the area of Information and Decision Science, in Knowledge Management and Organizational Learning research fields.



## RESEARCH TOPICS

The areas of research pursued by the team members are wide-ranging: developing business models of electronic marketplaces and measurement of electronic service quality, a systemic analysis of organizational design and the performance of inventory control systems, formal modelling for the different organisational learning mechanisms and causal mapping applications in managerial decision-making.

## CURRENT RESEARCH PROJECTS

Several research projects are conducted by the team members in close collaboration with industrial partners.

### Biz project

Conducted in collaboration with LSIS, Laboratory of Sciences of Information and Systems, CNRS, France, this project is about embedding the end-users in the co-conception of a new Internet-based platform that aims at developing new collaborative practices, and putting together, on a contractual basis, both the needs of the companies and the service offering of self-employed individuals.

## Experiment with interactive and immersive HMD

This project consists in an experiment with interactive and immersive HMD (360 degrees vision and egocentric view) in partnership with ORANGE. We analyze the relationship between new technology and rupture in studying this interactive and immersive 3D device (Spheric) which allows network connection sensory experiences. Our problem is to examine if this device is a real rupture (social, cognitive, communicative, emotional...) in the individual and organizational field.

## Summary of the research work of PRODIGE

The team has been involved in the research project 'PRODIGE' since November 2009. The project is funded (2.3 million Euros) by the National Agency of Research (ANR, France) and is conducted in collaboration with the University of Bordeaux 1, the engineering school EIGSI la Rochelle and the companies GT SA, Geoloc Systems and Inovelec. The aim of the project is to develop a technical and an organizational solution for an intelligent routing of products within supply chains. A prototype of the technical solution has been developed based on the RFID technology and geolocation solutions. In the first phase of the experimental part of the project, the performance of the prototype has been tested in the case where the RFID tags are placed on pallets loaded on a static truck. The optimal position of the antennas in the truck and the optimal location of the tags on the pallets have also been determined. The last steps of the research consisted in performing other tests of the prototype when the truck moves in a real route to make some pickup and delivery tasks. These simulations aim to test some developed routing optimization algorithms, the reading of the tags when pallets are loaded or unloaded during the route and also the information system that controls the pallets during the entire transportation activity.



## PUBLICATIONS

*Kimble, C., 2013, "What Cost Knowledge Management? The Example of Infosys", Global Business and Organizational Excellence, Vol. 32, n°3, p. 6–14.*

*Kimble, C. & Bourdon, I., 2013, "Editorial: Special issue on Knowledge Sharing within Knowledge Intensive Organizations", International Journal of Information Technology and Management, Vol. 12, n°3/4, p. 143–147.*

*Kimble, C. & Wang, H., 2013, "China's new energy vehicles: value and innovation", Journal of Business Strategy, Vol. 34, n°2, p. 13–20.*

*Lombardo, E. & Angelini, C., 2013, "Do Experiments Using Immersive and Interactive 3D Structures Improve Memorization?", Journal of Information Systems Applied Research, Vol. 39, n°1, p. 39–48.*

*Podinovski, V., Bouzdine-Chameeva, T., 2013, "Weight Restrictions and Free Production in Data Envelopment Analysis", Operations Research, Vol. 61, n°2, March-April 2013, p. 426–437*

*Rostami-Tabar, B., Babai, M. Z., Syntetos, A. A. & Duçq, Y., 2013, "Demand forecasting by temporal aggregation", Naval Research Logistics Quarterly, Vol. 60, n°6, p. 479–498, Septembre 2013.*

*Syntetos, A. A., Lengu, D., Babai, M. Z., 2013, "A note on the demand distributions of spare parts", International Journal of Production Research, 2013.*

*Wang, H., & Kimble, C., 2013, "Innovation and Leapfrogging in the Chinese Automobile Industry: Examples From Geely, BYD, and Shifeng", Global Business and Organizational Excellence, Vol. 32, n°6, p. 6–17.*



## CONTACT DETAILS

### OIHAB ALLAL-CHÉRIF

Head of Operations Management and Information Systems Department

Kedge Business School  
680 cours de la Libération  
33450 Talence, France  
P +33 556844200  
www.kedgebs.com  
oihab@kedgebs.com

## KEY FACTS

### INSTITUTION

- Founded in 1874
- One of the oldest „Grandes Ecoles“ en France
- 20 programs
- 120 permanents professors
- EQUIS, AMBA and AACSB accredited

### RESEARCH TOPICS

- IS in Operations Management
- Purchasing and IS
- e-distribution, e-commerce, e-business
- Supply Chain and OM Decision-Making & Decision Analysis
- Organizational Learning, Knowledge Management, Competences
- Electronic Marketplaces
- Serious games



# QUEENSLAND UNIVERSITY OF TECHNOLOGY – SCIENCE AND ENGINEERING FACULTY – INFORMATION SYSTEMS SCHOOL



## ABOUT THE INSTITUTION

Queensland University of Technology's Information Systems School is one of Australia's premier and largest institutions for Information Systems research.

The Information Systems School has a vision to change the world by connecting processes, information, services and people, and aims to shape the future of Information Systems via its uncompromising focus on rigorously evaluated and highly relevant research which influences its field and provides immediate value to students and industry partners

QUT has produced more award-winning doctorate students in the field than any other Australian university, with students awarded best Australian PhD thesis in Information Systems. Our solid reputation has led to the university successfully hosting the most significant regional IS conferences in this discipline (ACIS 2010, PACIS 2011). In the 2013 ranking of universities based on their publications in the top six Information Systems journals worldwide, QUT ranks no 40, higher than any European or Australian university for the period 2008–2012.

QUT's Information Systems School is one of six schools in the Science & Engineering Faculty at QUT. With more than 9000 students studying over 100 courses and more than 800 researchers working to-

wards new discoveries, the faculty is QUT's realisation of the goal to be a leader in the development of courses and research in the fields of science, technology, engineering and mathematics (STEM). The School moved in January 2013 into the new \$230 million Science and Engineering Centre (picture) allowing for collaborations with other disciplines and schools.

The School is involved in the following under-graduate and post-graduate courses

- Bachelor of Information Technology
- Bachelor of Games and Interactive Entertainment
- Masters of Information Technology
- Masters of Business Process Management

At the end of 2013, 86 PhD students are enrolled at the Information Systems School with approx. 50% of them being international students. In 2013, 25 PhD students graduated.

## RESEARCH DISCIPLINES

Research within the School is decomposed into three Disciplines, i.e.

- Business Process Management
- Service Sciences
- Information Ecology

The Business Process Management (BPM) Discipline is one of the most influential in the world, and its research is widely quoted and adopted by organisations. Research

members have authored and edited leading BPM textbooks, and developed core artifacts including the open source process modeling repository APROMORE, the open source workflow environment YAWL and a BPM maturity model that is now adopted globally.

Services Science expertise is diverse and has a dedicated focus on the theoretical foundations, applications, technologies and impacts of services across organisations, industries, ubiquitous computing environments and the Web. Key research focuses on empirical and business-related methodologies, conceptualisation of services, architecture and provisioning of services, service delivery platforms, public/private cloud infrastructure, and mobile and smart device service consumption. QUT aims to develop new models and capabilities for service innovation beyond conventional organisational and application boundaries in complex business ecosystems and Web-based communities.

Information Ecology investigates understanding, modelling, enhancing and enabling contextual connections between information, people and their environment. It aims to improve how people and enterprises share, comprehend, and effectively use and interact with structured and unstructured information. Binding these investigations is the contextual connections from which meaning is developed from information, whether mediated through systems or interactions with other people, individually, or in groups.

In 2013, a number of IS School members have been invited to conduct invited keynotes at some of the world's leading events in their domains, including the opening keynotes by Michael Rosemann at Gartner's BPM Summit (London, March); his opening keynote at the SAP Business Transformation Congress (Washington, September), Christine Bruce's invited keynote at the European Conference on Information Literacy

(Istanbul, October) and Alexander Dreiling's presentation at the Airport Exchange conference (Doha, Qatar, November).

## CURRENT RESEARCH PROJECTS

The Information Systems School is currently conducting a number of large, in many cases cross-disciplinary research projects including

- Airports of the Future
- Risk-aware Business Process Management
- Cost-aware Business Process Management
- Advanced Process Model Repositories
- Information Literacy
- Measuring IT Impact

Two industry-funded Chairs, The Brisbane Airport Corporation Chair of Airport Innovation and the Woolworths Chair of Retail Innovation showcase significant commitment and appreciation by industry partners. As Chair of Airport Innovation, Associate Professor Alexander Dreiling focuses on the design of a digital strategy and his strategy facilitates new revenue models including increased service brokerage models. As Chair of Retail Innovation, Professor Jan Recker leads a team in developing new ways of identifying innovation potential in retail. A main impact of this initiative in 2013 has been a multi-million dollar savings for Woolworths based on massively improved forecasting algorithms for promotional stocks. Further industry-funded projects are related the deployment of cross-organisational process mining in the insurance sector (partner: Queensland Government), the development of a framework for value-driven BPM Governance (partners: Accenture and Stevens Institute of Technology) and the orchestration of transformational services (partner: SAP).

## PUBLICATIONS

2013 has been another very successful year in terms of publications including a number of books, journals papers in MISQ, EJIS and Information Systems among others and a range of conference papers including six accepted ICIS 2013 papers and

a paper that won the BPM 2013 best paper award.

*Seidel, S., Recker, J., vom Brocke, J. (2013): Sensemaking and Sustainable Practicing: Functional Affordances of Information Systems in Green Transformations. Management Information Systems Quarterly, Vol. 37, No. 4, pp. 1275–1299*

*Darshana Sedera, Rebekah Eden and Ephraim McLean: Are We There Yet? A Step Closer to Theorizing Information Systems Success. In Proceedings of the International Conference on Information Systems (ICIS 2013), Milano, Italy, 15–18 December 2013.*

*Recker, J. (2013): Empirical Investigation of the Usefulness of Gateway Constructs in Process Models. European Journal of Information Systems, Vol. 22, No. 6, pp. 673–689.*

*Conforti, R., La Rosa, M., Fortino, G., ter Hofstede, A., Recker, J., Adams, M.: Real-Time Risk Monitoring in Business Processes: A Sensor-based Approach. Journal of Systems and Software, Vol. 86, No. 11, pp. 2939–2965.*

*C. C. Ekanayake, M. Dumas, L. Gacia-Banuelos, and M. La Rosa: Slice, Mine and Dice: Complexity-Aware Discovery of Business Process Models. Proceedings of the 11th International Conference on Business Process Management (BPM 2013), Beijing, 26–30 August 2013 (winner of the best paper award).*

## DISSERTATIONS

*Anitza A. Geneve: Woman's participation in the Australian Digital Content Industry.*

*Kinley: Towards Modelling Web Search Behaviour: Integrating Users' Cognitive Styles.*

*Karsten Ploesser: A Design Theory for Context-Aware Information Systems*

*Sebastian Reiter: Culture in Global Business Transformation Projects: The Discovery of a Grounded Theory*



## CONTACT DETAILS

**PROF. DR. MICHAEL ROSEMANN**  
Head of School

Queensland University of Technology,  
Science and Engineering Faculty  
2 George Street  
Brisbane QLD 4000,  
Australia  
P +61 7 3138 9473  
[www.qut.edu.au/informationssystemsschool](http://www.qut.edu.au/informationssystemsschool)  
[m.rosemann@qut.edu.au](mailto:m.rosemann@qut.edu.au)  
twitter: QUTInfoSystems

## KEY FACTS

### INSTITUTION

- Established in 1989
- 42 000 students
- Information Systems School, 29 academics, 90 PhD

### RESEARCH TOPICS

- Business Process Management
- Services Sciences
- Information Ecology



**Copenhagen  
Business School**  
HANDELSHØJSKOLEN

## ABOUT THE INSTITUTION

The Department of Information Technology Management (ITM) is one of the largest ITM departments in Europe. ITM is a multi-disciplinary department that embraces theories and methods from the fields of information systems, business administration, computer science, organization studies, political science, economics, sociology, psychology and communication theory. The mission statement of the department is: Co-creating knowledge with enduring consequences through the study of the inter-relationships among people, information and technology.

The Association of Information Systems (AIS) is the core community of the department. The AIS community is inclusive and open to all the current research areas of the department. With our journal contributions to the Senior Scholars' Basket of Journals we are ranked number two in Europe. Other communities are also relevant, e.g., human-computer interaction, e-government, organization studies, learning sciences, and software design and development.

We strive for a high level of collaboration with representatives from industry and society (also called engaged scholarship) while also organizing our research to accommodate for the fast-moving pace and radical innovation that characterizes the IS research field. We achieve this by organizing part of our research around themes

that address societal or business challenges. The themes are topical, popular, inter-disciplinary and dynamic in nature. In addition to the research themes, ITM still maintains the more traditional research areas for the disciplinary development of its researchers.

The faculty and administrative staff of the department are primarily teaching within the following degree programs: Bachelor in Business Administration and Information Systems, Bachelor in Information Management, MSc in Business Administration and Information Systems and the MSc in IT (eBusiness).

## RESEARCH TOPICS

The Department of IT Management conducts research within the following research areas related to information technology and information systems: Design, Implementation, Use and exploitation and Information management.

The research at ITM is organized around a number of cross disciplinary themes and we cover a number of research areas like mergers & acquisition, social media, cashless society, internet of things, or open big data.

Themes are emergent, topical, inter-disciplinary and dynamic in nature. They emerge from bottom up activities where researchers find that they share a common excitement about a new phenomenon and

encompass several tenured faculty members who meet regularly about a common research phenomenon over a longer period of time.

Example Research Theme IoT. The group 'Internet of Things' (IoT) has the objective to create an Internet of People and Societies by creating multidisciplinary and cross-disciplinary approaches with researchers, politicians, citizens, NGO's and enterprises pursuing socially productive scenarios in the merging of our physical world and the virtual world.

## CURRENT RESEARCH PROJECTS

**Cashless Society.** The vision behind 'Cashless Society' is to make Denmark the first cashless society in the world. Compared with the rest of the world, the Danish based entirely unique, and the cashless society will only further strengthen Denmark's international competitiveness. The idea of a cashless society leads to a number of issues and challenges that will be explored and investigated. Some of the key research questions are: How does the digitization of money affect the use and experience of money? How does the digitization of transactions influence the performance of and preference for different payment systems? How can we design a digitized payment ecosystem? The complexity in the challenges requires us to apply multi methodological approach ranging from anthropological studies, field studies, experiments, and design science in close collaboration with practice, including, including The Danish Bankers Association, NETS, Dansk Bank, Cell Point Mobile, IBM, and Innovation Lab.

**Digital Piracy.** There are next to no hard, independent data on game piracy, across AAA-levels to indie games, despite numerous reports about massive piracy rates reported for all types of games (as high as several hundred percent). The Digital Game Piracy project is in collaboration with international colleagues collecting extensive data about bittorrent activities for hundreds of games, correlating these with geographic-, market- and game variables to explore the patterns of game piracy across

national boundaries. This research will aid the gaming industry by providing an understanding of the dynamics of the market and enable it to cater to it more effectively.

**NEXT-TELL.** Our vision of the 21st Century classroom is that of a technology- and data-rich environment that supports teachers and students to use various sources of information generated in the classroom and during homework in pedagogical decision-making. Such an information infrastructure will improve instruction, diagnosis, workflow, and productivity as well as enhance collaboration and communication among students, teachers, and other stakeholders, especially parents. Teachers in particular will be supported in their function as diagnosticians who have to make constantly and rapidly decisions in a highly dynamic and complex environment. To bring this vision to life, we collaborate in the project NEXT-TELL, an integrating project (ip) in the ICT challenge of the 7th framework programme of the European Commission. NEXT-TELL's main objective is to provide, through research and development, computational and methodological support to teachers and students.

**3gERP.** The enterprise resource planning (ERP) software market is deeply fragmented. For small and medium sized enterprises (SME) the number of vendors is around 10 000 globally. With so many options market leadership is difficult, standardization next to impossible and the achievement of economy of scale not easy. In this context, the 3gERP project aims to develop a standardized, yet highly configurable and flexible, global ERP system for SME's based on fundamentally new software architecture. This would make implementation and maintenance possible at a fraction of their current cost.

## PUBLICATIONS

*Jannis Kallinikos; Aleksis Aaltonen; Attila Marton* / The Ambivalent Ontology of Digital Artifacts. In: MIS Quarterly, Vol. 37, No. 2, 6.2013, p. 357–370

*Eric Clemons; Jonas Hedman; Saonee Sarker; Daniel Veit* / Information Systems Journal Special Issue in the 'Digitisation in Business Models and Entrepreneurship'. In: Information Systems Journal, Vol. 23, No. 3, 2013, p. 277–279

*Matthias Trier; Judith Molka-Danielsen* / Sympathy or Strategy: Social Capital Drivers for Collaborative Contributions to the IS Community. In: European Journal of Information Systems, Vol. 22, No. 3, 5.2013, p. 317–335

*Xiao Xiao; Christopher B. Califf; Saonee Sarker; Suprateek Sarker* / ICT Innovation in Emerging Economies: A Review of the Existing Literature and a Framework for Future Research. In: Journal of Information Technology, 2.7.2013.

*Karlheinz Kautz; Tina Blegind Jensen* / Sociomateriality at the Royal Court of IS: A Jester's Monologue. In: Information and Organization, Vol. 23, No. 1, 2013, p. 15–27

*Chee-Wee Tan; E. Berghout* / Understanding the Impact of Business Cases on IT Investment Decisions: An Analysis of Municipal e-government Projects. In: Information & Management, Vol. 50, No. 7, 2013, p. 489–506

*Philip Yetton; Stefan Henningsson; Niels Bjørn-Andersen* / "Ready to Acquire" : The IT Resources Required for a Growth-by-Acquisition Business Strategy. In: MIS Quarterly Executive, Vol. 12, No. 1, 2013, p. 19–35.

*P. Svejvig; Tina Blegind Jensen* / Making Sense of Enterprise Systems in Institutions: A Case Study of the Re-implementation of an Accounting System. In: Scandinavian Journal of Information Systems, Vol. 25, No. 1, 2013, p. 3–35

*Jonas Hedman; Mikael Schonström* / Managerial and Ontological Issues in the Development of Enterprise Architecture: Experiences from a Case Study. In: Journal of Enterprise Architecture, Vol. 9, No. 2, 5.2013, p. 44–53



## CONTACT DETAILS

**DR. MATTHIAS TRIER**  
Associate Professor,  
Department of IT Management

Copenhagen Business School  
Howitzvej 60, 4<sup>th</sup> floor  
DK-2000 Frederiksberg,  
Denmark  
P +4815 2047  
[www.cbs.dk/itm](http://www.cbs.dk/itm)  
[mt.itm@cbs.dk](mailto:mt.itm@cbs.dk)

## KEY FACTS

### INSTITUTION

- 20 tenured faculty
- 16 PhD candidates
- Plus a number of assistants, lecturers, adjuncts, external employees

### RESEARCH TOPICS

- Information Management
- Social Media Management
- Social Media Analytics
- IT in Mergers and Acquisitions
- IT Strategy and Organization
- Internet of Things
- Open Data, Big Data
- Electronic Communication
- Human Computer Interaction
- Systems Development
- E-Government



## UNIVERSITY OF TWENTE.

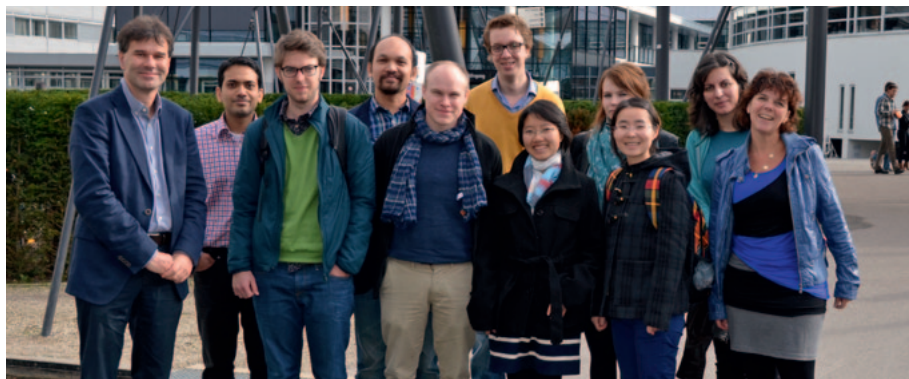

PhD seminar at the University of Twente

### ABOUT THE INSTITUTION

The University of Twente is where talent can best realize its full potential. Students and staff are the key. Together, 3300 scientists and professionals carry out groundbreaking research, bring about socially relevant innovation, and provide inspiring teaching for more than 9000 students. To us, entrepreneurship comes as second nature. The campus is home to around 100 businesses, including student-run businesses. The University of Twente has also generated more than 700 successful spin-off companies including well known E-businesses such as Booking.com and take-away.com. The university's business park, Kennispark Twente, encourages and assists entrepreneurs to start new companies. But there's so much more than that happening on our wonderful, green campus. Our sports and cultural facilities are unique and we host events such as the world's largest student think tank, Create Tomorrow. Another legend of the Twente campus is the Netherlands' largest student sports event, the Batavieren Race. The campus is a hive of activity – a truly inspirational place to be! – University of Twente, the entrepreneurial university.

The UT has ICT and Information Systems Research among its focus areas. The Center for Telematics and ICT (CTIT) is the largest ICT research institute in the Netherlands and among the largest in Europe. CTIT is involved in more than 30 EU funded research projects and generates around 7 spinoff companies per year. CTIT recently

co-founded ICT labs, a European EIT dedicated towards accelerating ICT innovations in business.

### RESEARCH TOPICS

The research of CTIT is organized in centres that bundle efforts and closely align to topics addressed in the Dutch top-sector agenda and the European Horizon2020. The CTIT centers are:

- Centre for Dependable Systems and Networks (C.DSN)
- Centre for Cyber Security and Public Safety
- Centre for Interactive Service Robotics
- Centre for Green ICT
- Centre for Array Technology (CAT)
- Centre for Wireless and Sensor Systems (WISE)
- Centre for Healthcare Operation Improvement (CHOIR)
- Centre for Sustainable Supply Chain Innovation (SSI)
- Centre for Tele-monitoring and Coaching
- Centre for Service Science

Various departments are joining efforts in these centers to address research challenges in an interdisciplinary way. More information on the centers can be found via [www.ctit.nl](http://www.ctit.nl).

### CURRENT RESEARCH PROJECTS

CTIT is active in dozens of research projects financed at the national and European level and directly by industry. Departments directly related to ERCIS research themes are the IEBIS (Industrial Engineering and Business Information Systems) group and the SCS (Services, Cybersecurity and Safety research group).

The IEBIS group is concerned with studying novel ways of managing business processes and supply chains using innovative techniques such as simulation, (social) data mining, multi-agent coordination and gamification. Researchers in IEBIS use design science methods to develop Decision Support Systems and Inter-Organizational Systems connecting networks of businesses and governments.

The goal of the SCS group is to develop methods and techniques for developing IT-based services that balance service levels with safety- and security levels, and to develop methods and techniques that make existing IT-based services more secure.

Selected research projects include:

**Catalog** – Ebusiness architecture and fulfillment

**COSMOS** – The design of a method to support benefits identification and distribution in an inter-organisational setting.

**IOP-GENCOM** – Business modeling using multiple architectural layers to arrive at a solution architecture that describes both business value and process and service architecture

**BME** – A method to support business model engineering

**BATMAN** – Barge Terminal Multi-Agent Network. Design and implementation of an inter-organisational system for dynamic coordination between terminals and barge operators in the port of Rotterdam

**Social media content analysis** – Data-driven service development. Integrating Internet and social media content reports with internal log data for service development decisions

**TREsPASS** – Methods and tools to analyse and visualise information security risks in dynamic organisations, as well as possible countermeasures.

### PUBLICATIONS

*Haan, Georg Hendrik and Hillegersberg, Jos van and Jong, Eelco de and Sikkel, Klaas (2013)* Adoption of wireless sensors in supply chains: a process view analysis of a pharmaceutical cold chain. *Journal of Theoretical and Applied Electronic Commerce Research*, 8 (2). pp. 138–154. ISSN 0718–1876

*Daneva, Maya and Veen, Egbert van der and Amrit, Chintan and Ghaisas, Smita and Sikkel, Klaas and Kumar, Ramesh and Ajmen, Nirav and Ramteerthkar, Uday and Wieringa, Roel (2013)* Agile requirements prioritization in large-scale outsourced system projects: An empirical study. *Journal of systems and software*, 86 (5). pp. 1333–1353. ISSN 0164-1212

*Amrit, C. and Hillegersberg, J. van and Diest, B. van (2013)* Involving end users to mitigate risk in IS development projects. *Journal of organizational and end user computing*, 25 (3). 67–82. ISSN 1546-2234

*Katsma, Christiaan and Amrit, Chintan and Hillegersberg, Jos van and Sikkel, Klaas (2013)* Can Agile Software Tools Bring the Benefits of a Task Board to Globally Distributed Teams? In: *Advances in Global Sourcing. Models, Governance, and Relationships*, 7<sup>th</sup> Global Sourcing Workshop 2013, Val d'Isère, France, March 11–14, 2013, Revised Selected Papers. Lecture notes in business information processing, 163. Springer, Berlin, pp. 163–179. ISBN 9783642409509

*Kadka, Ravi and Sapkota, Brahmananda and Ferreira Pires, Luis and Sinderen, Marten van and Jansen, Slinger (2013)* Model-driven approach to enterprise interoperability at the technical service level. *Computers in industry*, 64 (8). pp. 951–965. ISSN 0166-3615

### DISSERTATIONS

*Margreet Michel* – Verkerke, Electronic Patient Record: What makes care providers USE IT?

*Mohammad Zarifi Eslami*, Service tailoring: a method and tool for user-centric creation of integrated IT-based homecare services to support independent living of elderly.

*Lucas Meertens*, Relating business modeling and enterprise architecture



## CONTACT DETAILS

**PROF. DR. JOS VAN HILLEGERSBERG**

Centre for Telematics and Information Technology

University of Twente  
Drienerloaan 5,  
7522 NB Enschede  
The Netherlands  
P +31 53 489 9111

IEBIS: [www.utwente.nl/mb/iebis](http://www.utwente.nl/mb/iebis)

Head of department:  
Prof. Dr. Jos van Hillegersberg  
[j.vanhillegersberg@utwente.nl](mailto:j.vanhillegersberg@utwente.nl)

SCS: [scs.ewi.utwente.nl](http://scs.ewi.utwente.nl)

Head of department:  
Prof. Dr. Roel Wieringa

CTIT: [www.ctit.nl](http://www.ctit.nl)  
Scientific director:  
Prof. Dr. Peter Apers

## KEY FACTS

### INSTITUTION

- Center for Telematics and IT
- One of the largest academic ICT research institutes in Europe
- 375 researchers / 239 fte
- Budget 29 Million Euro





## ABOUT THE INSTITUTION

With almost 33 000 students, eleven faculties and about 1 700 academic staff members, the University of Gdansk is the largest institution of higher education in the Pomeranian Region. It offers an opportunity to do studies in one of almost thirty different fields including over a hundred specializations.

The Department of Business Informatics (BI) at the University of Gdansk is involved in research and teaching in the field of BI on Bachelor, Master and Doctoral levels in accordance to Bologna process standards. The Department is the main contributor to the e-Learning Educational Platform of the University of Gdansk.

Moreover, it coordinates the Pomeranian Regional CISCO Academy, which conducts numerous courses for computer network administrators who receive international certificates upon successful completion of studies. Master theses and doctoral dissertations supervised by the Department of BI staff members received special attention at the International Business Informatics Challenge organized by the Dublin University and the Polish Research Society for Business Informatics.

Furthermore, the Department conducted the Observatory of Pomeranian Digital Economy and founded the Polish Research Society for Business Informatics.



The Department of Business Informatics at the University of Gdansk has cooperated with academic centres from the Baltic Sea Region in the following Trans Baltic initiatives:

- Baltic Sea Virtual Campus (BSVC) – consortium developing and implementing e-Learning courses
- Doctoral Consortium Methodologies for Interactive Networked Enterprises (MINE), financed by the Nordforsk Council of Ministers (2005-2009)

The Department is also involved in the following international and domestic initiatives:



- The Polish Chapter of Association for Information Systems (PLAIS)
- The Annual AIS SIGSAND/PLAIS EuroSymposium on Systems Analysis and Design



- The Annual International conference on Perspectives in Business Informatics Research (BIR Conference)



- Information Systems Academic Heads International (ISAHI)



- NTIE – Polish Research Society for Business Informatics

## RESEARCH TOPICS

The areas of research interest at the Department of Business Informatics cover the following themes:

- Business Informatics
- Data Bases
- Information Systems Development
- E-Business, Information Society
- Business Systems Modelling
- UML and SysML
- ERP, CRM, SCM, WFM, BI Systems
- E-Learning
- Computer Programming
- Computer Networks

## CURRENT RESEARCH PROJECTS

The Department of Business Informatics is involved in the following research projects:

- Development and launching of the Master Studies specialisation Informatic Applications in Business at the Faculty of Management of the University of Gdansk

- University of Tomorrow: Internationalization of Education at University of Gdańsk by Co-operation with University Houston-Downtown (USA): The Determinants of the Acceptance and Adoption of Uptodate Academic e-learning

## AWARDS

- First Place for Doctoral Dissertation of Michal Kuciapski (Management Model of e-Learning Projects Development, University of Gdansk, 2012) at the Polish Research Society for Business Informatics Contest for Doctoral Dissertations. The dissertation was supervised by Prof. dr hab. Stanislaw Wrycza

- Prof. dr hab. Stanislaw Wrycza was awarded the Officer's Cross Order of Polonia Restituta given by Polish President

## EVENTS

- The 6<sup>th</sup> SIGSAND/PLAIS EuroSymposium' 2013 (Gdansk, Poland).

## PUBLICATIONS

*Wrycza, S. 2013.* LECTURE NOTES IN BUSINESS INFORMATION PROCESSING 161, Gdańsk, Poland, 2013, Proceedings, Series: LNBIP 161, Springer

*Jatkiewicz, P. 2013.* "Identifying Factors of an Information Security Management System of Local Self-government Bodies", LECTURE NOTES IN BUSINESS INFORMATION PROCESSING 161, Gdańsk, Poland, 2013, Proceedings, Series: LNBIP 161, Springer

*Marcinkowski, B., Ostrowski, P. 2013.* "Considerations in Introducing a Blended Learning Environment Dedicated to Training Computer Network Administrators", LECTURE NOTES IN BUSINESS INFORMATION PROCESSING 161, Gdańsk, Poland, 2013, Proceedings, Series: LNBIP 161, Springer

*Maslankowski, J., 2013.* "The Integration of Web-Based Information and the Structured Data in Data Warehousing", LECTURE NOTES IN BUSINESS INFORMATION PROCESSING 161, Gdańsk, Poland, 2013, Proceedings, Series: LNBIP 161, Springer

*Marcinkowski, B., Gawin B. 2013.* "Business Processes Simulation. BPMS and BPMN in Practise", Helion, Poland, 2013 (book in Polish)

*Maslankowski, J. 2013.* "A Concept of Multi-layer modeling of Business Intelligence Systems", STUIDA INFORMATICA vol. 34, 2B (112), Selisian Technical University, Gliwice, Poland, 2013 (book in Polish)

## DISSERTATIONS

*Harasimiuk, A.* The Reference Models of Processes and Services of Financial Intermediation with Application of BPMN and SOA Methods, University of Gdansk, 2013, supervisor – Prof. S. Wrycza (in Polish)



## CONTACT DETAILS

PROF. DR HAB. STANISLAW WRYCZA

University of Gdansk  
Piaskowa 9, 81-864 Sopot, Poland  
P +48 58 523 1400  
kie.wzr.ug.edu.pl and wrycza.wzr.pl  
swrycza@univ.gda.pl  
skype: swrycza

## KEY FACTS

### ABOUT THE PERSON

- Head of the Department of Business Informatics
- Editorial Board Member of the Journal of Database Management
- Senior Editor of the Information Management Journal
- Editorial Board Member of the Information Systems Journal
- Editorial Board Member of the Information Systems and e-Business Management, Springer
- Steering Committee Member of the Annual International Conference on Business Informatics Research (BIR)
- Steering Committee Member of the Baltic Sea Virtual Campus (BSVC)
- Honourable Ambassador of Polish Congresses

### INSTITUTION

- Founded in 1967
- Researchers: 12 staff members and 14 doctorate students





## ABOUT THE INSTITUTION

The Department of Information Systems at the Kaunas University of Technology (KTU) was founded in 1993 as a result of more than 20 years of research in the field of information systems (IS). Since then, we have grown to become one of the leading departments in the KTU Faculty of Informatics. In 2012, the Department's Laboratory of Information Systems and Databases Design was restructured into the Centre of Information Systems Design Technologies (headed by prof. R. Butleris) that allowed to extend our research capabilities even further. Being among the leading IS research hubs in Lithuania, the Department has built good relationships with the local IT companies and accumulated valuable research experience with Lithuanian and international partners.

Our academic work is directed towards providing quality education on fundamental and advanced subjects in the field of information systems. The Department is responsible for both first and second cycle study programmes titled "Information Systems" and "Information Systems Engineering" respectively. In 2013, 35 students were accepted to the Bachelor study programme, and 25 – to the Master's. There were also 10 PhD students at the Department.



## RESEARCH TOPICS

The KTU Department of Information Systems specializes in topics related to Information Systems Engineering. Majority of our R&D activities are carried out within the following topics:

- Conceptual modeling, ontologies and databases
- Requirements specification
- Modeling of business processes and business rules
- Semantic Web languages and technologies
- Enterprise modeling
- Information systems engineering
- Model-driven and service-oriented development
- Project management
- Business analysis and intelligence
- Knowledge-based systems
- Information systems user interface and usability

## CURRENT RESEARCH PROJECTS

Here are the main projects the Department staff has been involved in in 2013:

- Syntactic and Semantic Analysis and Search System for Lithuanian Internet, Corpus and Public Sector Applications in Lithuanian Language (2012-2014). Financed by the EU Structural Funds under the Economy Growth Activities Programme, project coordinator – Vytautas Magnus University (Lithuania). At the end of 2013 we expect to launch the syntactic-semantic analysis and search management component. It will allow evaluation of previously developed chains of text annotation and semantic search on the Web.

- Business Semantics Based Integration of Business Processes and Business Rules (2013-2015), with No Magic Europe. Financed by the EU Structural Funds under the Human Resources Development Programme. The key result of this year's work was the theoretical framework integrating three OMG modeling standards: BPMN, SBVR, and UML.

- Research and Development of Internet Technologies and their Infrastructure for Smart Environments of Things and Services (2012-2015). Financed by the EU Structural Funds under the Human Resources Development Programme. In 2013, our main contribution to this large scale initiative was work on the method of web services generation from the rules enriched business process models.

- Provision of Youth Consulting and Guidance Services in the Public e-Space (2012-2015). Financed by the EU Structural Funds under the Economy Growth Activities Programme, project coordinator – Youth Matters Department under the Ministry of Social Security and Labor of Lithuania.

At the same time we have continued collaboration with the State Forest Survey Center developing the new National Forest Inventory IS. Several smaller scale R&D projects were also carried out in cooperation with local enterprises, and with the support of the Lithuanian Agency for Science, Innovation and Technology

## EVENTS

- 19<sup>th</sup> International Conference on Information and Software Technologies, ICIST 2013. Kaunas, Lithuania, October 10–11.
- 20<sup>th</sup> Anniversary of the Department. Kaunas, October 25<sup>th</sup>.

## PUBLICATIONS

*A. Lopata, M. Ambraziunas, S. Gudas, R. Butleris, R. Butkiene (2013):* Enterprise knowledge-based generation of class model, Electronics and Electrical Engineering, Vol. 19, No. 2, pp. 79–82.

*S. Pavalkis, L. Nemuraite, R. Butkiene (2013):* Derived properties: a user friendly approach to improving model traceability, Information Technology and Control, T. 42, No. 1, pp. 48–60.

*V. Sakys, K. Kapocius, R. Butleris, A. Lopata, S. Gudas (2013):* The framework for business intelligence driven analysis of study course teaching efficiency, Transformations in Business & Economics, Vol. 12, No. 1a, pp. 429–442.

*T. Skersys, R. Butleris, K. Kapocius, T. Vileinskis (2013):* An approach for extracting business vocabularies from business process models, Information Technology and Control, T. 42, No. 2, pp. 178–190

*L. Tutkute, R. Butleris, V. Uzdnaviciut, E. Sinkevicius, T. Skersys, K. Kapocius (2013):* Improving quality of business models using a business vocabulary-based synchronization method, Electronics and Electrical Engineering, Vol. 19, No. 6, pp. 125–130.

## DISSERTATIONS

*Lina Tutkute:* Integration of Business Vocabulary and Rules with Business Process Models

*Aurelijus Morkevicius:* Business and Information Systems Alignment Method Based on Enterprise Architecture Models



## CONTACT DETAILS

**PROF. RIMANTAS BUTLERIS**  
Department of Information Systems

Kaunas University of Technology  
Studentu 50–313 a  
LT-51368 Kaunas, Lithuania  
P+370 37 453445  
[isd.ktu.lt](http://isd.ktu.lt)  
[rimantas.butleris@ktu.lt](mailto:rimantas.butleris@ktu.lt)

## KEY FACTS

### INSTITUTION

- Founded in 1993
- Part of the KTU Faculty of Informatics
- More than 20 researchers

### RESEARCH TOPICS

- Conceptual modeling, ontologies and databases
- Requirements specification
- Modeling of business processes and business rules
- Semantic Web languages and technologies
- Enterprise modeling
- IS engineering
- Model-driven and service-oriented development, project management
- Business analysis and intelligence
- Knowledge based systems
- Systems user interface and usability





## ABOUT THE INSTITUTION

The Department of Information Systems (IS) is one of the six departments within the Faculty of Economics and Social Sciences at the University of Agder (UiA). With 18 researchers (15 in permanent positions and 3 adjunct professors) it is one of the largest IS departments in Norway.

The Department offers a three-year BSc in IT and IS programme, a one-year undergraduate study in IT and IS, a two-year MSc in IS programme, and a three year PhD in IS programme. Our MSc in IS programme was launched in 1999 as the first programme of this kind in Norway. The Department contributes actively to the IS community by publishing in leading IS journals, as well as hosting and participating in international IS conferences.

In addition to the Department of Information Systems, there is the Department of ICT at the University of Agder, which is responsible for education and research in the Computer Science and ICT Engineering fields.

## RESEARCH TOPICS

The research in the Department of IS is currently organized in two centres and one research group:

**Centre on e-Government (CeG)** focuses on how ICT can be used to improve government processes and communication with citizens, how citizen participation can be advanced through social networks and how ICT can further development in the less developed parts of the world. The Centre is involved in research, teaching and dissemination, and

is a leading e-Government research group in Norway.

**The Centre for Enterprise Systems (CENS)** was established as a response to the increasing demand for graduates with enterprises systems skills, both from the IS and the business programs. The Centre has two main goals: to provide hands-on enterprise systems modules in various IS and business courses, and to act as a resource centre for organisations on the acquisition, implementation and use of enterprise systems.

**The Research Group on Information Systems Development (ISD)** focuses on how information systems and software solutions are developed in and for organizations. Especially, the group views ISD as interaction between the processes of technical construction of software applications and organizational implementation.

In addition, the Department is part of two multidisciplinary centres at the University of Agder:

**The Centre for e-Health and Health Care Technology** focuses on teaching, research, development and testing of new technology for the health and social sector. Taking a user perspective, the aim of the centre is to make everyday life easier in today's health society by developing technological solutions such as smart house solutions and mobile home services.

**The Centre for Integrated Emergency Management (CIEM)** aims at releasing the potential of powerful evolving technologies for integrated emergency preparedness and management. The Centre conducts research on networks, mobile devices, human-centered sensing, social media, sensemaking, visualization, decision support, collective intelligence and technology adoption.



## CURRENT RESEARCH PROJECTS

The **Semicolon II** project (2011-2013) is funded by the Research Council of Norway and the participating government agencies. The project goal is to identify and address the issues related to interoperability. In particular, the project seeks to understand how interoperability generates various forms of value in the Norwegian public sector. The consortium behind Semicolon II includes several major government agencies, industry partners and four universities.

The **SmartEMIS** (Smart Emergency Management Information Systems) project (2012-2015) is funded by the Competence Development Fund of Southern Norway. The project focuses on how mobile devices, such as smart phones, combined with different forms of social media can be applied for improving information sharing and collaboration in crises. The project goal is to develop solutions and procedures to increase citizens' participation in emergency preparedness and management.

## PHD THESES

*Haddara, Moutaz,*  
ERP Systems in SMEs: Exploring ERP Life-cycle Cost Issues

*Johannessen, Marius,*  
Social Media as Public Sphere: An Exploratory Study of Online Communication in Norway

*Omland, Hans Olav,*  
Competence, Methods and Practice in Information Systems Development

*Wahid, Fathul,*  
The Role of Institutional Entrepreneurs in the Institutionalization of e-Government Initiatives in Developing Countries

## PUBLICATIONS

*Ø. Hellang, L. S. Flak, T. Päiväranta (2013):* Diverging Approaches to Benefits Realisation from Public ICT Investments: A Study of Benefits Realisation Methods in Norway. *Transforming Government: People, Process & Policy*, (7:1), pp. 93–108.

*E. Hustad, A. A. B. Arntzen (2013):* Facilitating Teaching and Learning Capabilities in Social Learning Management Systems: Challenges, Issues, and Implications for Design. *Journal of Integrated Design and Process Science*, (17:1), pp. 17–35

*J. Iden, T. R. Eikebrokk (2013):* Implementing IT Service Management: A systematic literature review, *International Journal of Information Management*, (33:3), pp. 512–523

*M. Johannessen (2013):* Political Social Media sites as Public Sphere: A Case Study of the Norwegian Labour Party, forthcoming in *Communications of the Association of Information Systems*

*C. E. Moe, T. Päiväranta (2013):* Challenges in Information Systems Procurement in the Public Sector, forthcoming in *Electronic Journal of e-Government*.

*S. D. Müller, P. A. Nielsen (2013):* Competing Values in Software Process Improvement: A Study of Cultural Profiles, *Information Technology and People* (26:2), pp. 146–171

*F. Wahid, M. K. Sein (2013):* Institutional Entrepreneurs: The Driving Force in Institutionalisation of Public Systems in Developing Countries, *Transforming Government: People, Process and Policy*, (7:1), pp. 76–92

*S. Westin, M. K. Sein (2013):* Improving Data Quality in Construction Engineering Projects: An Action Design Research Approach, forthcoming in *Journal of Management Engineering*



## CONTACT DETAILS

**PROF. DR. ING.**  
**BJØRN ERIK MUNKVOLD**  
Department of Information Systems

University of Agder  
Post Box 422  
NO-4604 Kristiansand, Norway  
P +47 38 141 000  
bjorn.e.munkvold@uia.no  
www.uia.no/is

## KEY FACTS

### INSTITUTION

- Founded in 1994 (from 2007 the UiA has full university status)
- Approximately 10 000 students and 900 staff members
- 18 IS researchers
- Approximately 300 Bachelor and Master in IS students
- 11 PhD students

### RESEARCH TOPICS

- E-Government and benefits realization
- E-Participation and e-Democracy
- ICT for development
- Enterprise systems implementation in SMEs
- Business process management and process modelling
- Knowledge management and e-Collaboration
- Systems development practice
- Emergency management IS





## ABOUT THE INSTITUTION

The Information Systems research group at Manchester Business School continues to evolve and pursue a diverse research and teaching agenda. The research focus remains on maintaining a balance between rigour and relevance in order to be able to meet the diverse demands of academic, student and management audiences.

The IS group teaches the Information Technology Management for Business (ITMB) undergraduate degree and this attracts a lot of attention from leading recruiters. This is reflected by the fact that students have the option to spend a year in industry before taking their final year. Current projects on this degree include mobile payment systems, use of social media in sports marketing, 'gamification' to improve company productivity and the evaluation of scan gun technology in retailing. MBS launched a new M.Sc. degree programme titled "Business Analytics" that seeks to integrate Information Systems with decision-making theory in a business-focused context. One of the modules on the degree, data analytics, explores the role and importance of 'big data' to help managers develop and evaluate business strategy.



*Dr. Julia Handl, Director of M.Sc. Business Analytics*

Dr. Julia Handl reports that the launch of the programme has been very successful, and that an important feature of the course is the interdisciplinary nature of the teaching that seeks to combine business and technology concepts with analytical skills. Faculty are also active on the PhD and DBA programmes with international students studying social media, robotics, electronic markets and online consumer behaviour.

Guest lecturers in 2012/2013 included senior managers and Directors from the insurance, telecommunications, business software, manufacturing and e-commerce sectors. Industry speakers are an important component of the teaching and provide an external perspective on contemporary business and technology trends to our undergraduate and Masters students

## RESEARCH TOPICS

Current research is focused on several inter-related areas: web 2.0 and social media in business and consumer markets, online panel data to support research into consumer behaviour, evaluation of Internet marketing strategy in a competitive context, social robots in a service context, the interpretation of 'big data', decision making in online environments, decision analytic tools and emergency management systems. The group continues to work closely with industry and commerce to support a range of applied research projects.



*Luca Sabini, Ph.D. candidate, LUISS Guido Carli University*

## Research Collaboration between LUISS Guido Carli University and MBS

Luca Sabini from LUISS Guido Carli University continued his research visit at MBS working with Prof. Daniel Muzio on a project on the professionalization of project management. Prof. Muzio and Luca organized a stream on IT and project management at this year's Itais conference in Milan and were members of the organizing team for the conference.

[www.itais.org/itais2013](http://www.itais.org/itais2013)

## Research Collaboration between MBS and Muenster University

Prof. Holland from MBS and Prof. Klein from Muenster have recently set up a new collaborative arrangement to explore the strategic analysis and interpretation of big data generated from online consumer activity in Germany and the UK. They are seeking funding for PhD students who will benefit from taking courses at both institutions and also network with other ERCIS research partners with similar interests.

## Social Robots in a Service Context

*Dr. Kathy Keeling, Senior Lecturer.*

Technological advances in the field of robotics have sparked a new generation of social and assistive robots. Typically, research on technology in service, including robots, focuses on user acceptance and usability of technology as a means of informing service design, with the inherent assumption that technology will deliver value in the service exchange. This understanding means that firms invest heavily in creating robots that have the most advanced capabilities rather than the most

appropriate capabilities to serve end-user needs. We question this assumption and argue that for robots to offer a viable route for service delivery, we must understand both the customer reactions to robots and the nature of how value is created in human to humanoid service exchanges. We propose that producers and designers of social and assistive robots use a 'service' logic approach that focuses on consumer perspectives of value that emerge from the consequences of human robot interaction (HRI) rather than the features and capabilities themselves. Our research explores consumers' understanding of social robots in a service context, with a focus on the customer end values. It also considers anthropomorphic attributions, attitudes and behaviour towards robots and how this will facilitate or otherwise the successful integration of robots into service environments.

## PUBLICATIONS

*Azadegan, Aida, Papamichail, K Nadia, and Sampaio, Pedro.* "Applying collaborative process design to user requirements elicitation: A case study." *Computers in Industry* 64, no. 7(2013): 798–812.

*Holland C.P.; Gordon D. Mandry.* 2012. Online Search and Buying Behaviour in Consumer Markets. In Hawaii International Conference on System Sciences 07 January 2013 – 10 January 2013. Maui, Hawaii, US: IEEE.

*Keeling KA, Keeling DI and McGoldrick PJ.* "Retail relationships in a digital age." *Journal of Business Research* 66, no. 7(2013): 847–855.

*Papamichail, K. N., & French, S.* "25 years of MCDA in nuclear emergency management." *IMA Journal of Management Mathematics*(2013).

*Paton S, Hodgson D, Muzio D.* The Price of Corporate Professionalisation: Analysing the corporate capture of professions in the UK and consequences for expert labour. *New Technology Work and Employment* 2013, 28(3).



## CONTACT DETAILS

### PROF. CHRISTOPHER P. HOLLAND

Manchester Business School  
Booth Street West  
Manchester  
M15 6PB, UK  
P +44 161 275 6460  
[www.mbs.ac.uk/research/people/profiles/cholland](http://www.mbs.ac.uk/research/people/profiles/cholland)  
[chris.holland@mbs.ac.uk](mailto:chris.holland@mbs.ac.uk)

## KEY FACTS

### INSTITUTION

- 4 senior members of staff
- 6 researchers
- 7 PhD and DBA students
- Several visiting faculty and researchers

### RESEARCH TOPICS

- Adoption of social media platforms by SMEs
- Web 2.0 and social media in a variety of organisational contexts
- Online consumer behaviour
- Enterprise systems
- Digital business models
- Online panel data
- Emergency management systems
- Decision analytic tools



Faculty of Organizational Sciences



## ABOUT THE INSTITUTION

The Faculty of Organizational Sciences is a founding member of the University of Maribor. It has been involved in research and education about the organizational and informational sciences for more than 50 years. Today it provides Bologna programs of Information Systems, Human Resource and Educational Systems, Business and Work Systems. During this period, the Faculty has taught a large number of graduates who have pursued employment in the manufacturing and service industries as well as governmental and educational institutions. Research area of Faculty of Organizational Sciences covers complex dynamic management systems, covering aspects from human resources, information systems, business processes and general management. Research is organized in many laboratories and in the eCenter. All are involved in research projects, prototyping, consulting, education and training at national and international level. Their activities have been organized and are run following the LivingLab approach, with a strong involvement of business and government organizations, users, IT providers and universities. The resulting eLivingLab is the Slovenian founding member of European Network of Living Labs (ENoLL). The Faculty has a wide range of experiences from many EU, national and industry projects. It is also very active in Living Lab and cross-border regional development initiatives. The Faculty has established connections with numerous institutes, faculties and universities around the world and strives to enhance its internationally

renowned reputation. Bilateral cooperation has occurred in several forms, including the exchange of higher education professors, participation in various research projects, and student exchange.

## RESEARCH TOPICS

Research area of the Faculty of Organizational Sciences is focused to investigation of complex dynamic management systems, covering various aspects from human resources, information systems, business processes and general management. The significant focus is in implementation of newest ICT and their impact on new business model development, and increasing effectiveness and efficiency of business and government organizations, ICT industry, universities and society as a whole.

The Faculty has established connections with numerous institutes, faculties, and universities around the world in order to enable cooperation between students, researchers, professors, and their counterparts at other institutions in teaching exchange programs, collaboration in research projects, and at conferences.

Research topics at the Faculty of Organizational Sciences:

- Management of Information systems
- eCommerce, eBusiness
- ERP systems
- Inter-organizational systems
- eGovernment
- Mobile commerce
- eHealth & Well-being
- eBusiness models
- Cloud computing

- Internet of Things
- Enterprise 2.0
- Social media, Web 2.0, eCollaboration
- eLearning 2.0 & eEducation
- eInnovations, Open innovation, Living labs
- Business processes management
- Decision support systems
- Simulation systems and models
- Knowledge management
- Organizational learning
- Business intelligence
- Big data, open data

## CURRENT RESEARCH PROJECTS

European Projects:

### CentraLab

Central European Living Lab for Territorial Innovation

Program: CENTRAL EUROPE PROGRAMME

Website: <http://www.centrallivinglab.eu>

### CO-Efficient

Collaborative framework for energy EFFICIENT SME systems

Program: Program Med – Transnacionalno teritorialno sodelovanje

### SDI4Apps

Uptake of Open Geographic Information Through Innovative Services Based on Linked Data

Program: CIP-ICT-PSP-2013-7

### GEPSUS

Geographical Information Processing for Environmental Pollution-Related Security within Urban Scale Environments

Program: NATO

Website: <http://www.graphitech.it/gepsus/>

National Research programme:

**Decision support systems in the global e-business**

Research programme, P5-0018

**Impact of management, organizational learning and knowledge management in modern organizations**

Research programme, P5-0364-0586

**Development of students' computer literacy for support of authentic natural science problem solving**

Research program: Slovenian Research Agency

**Economics of organic farming in Slovenia**

Research program: Slovenian Research Agency

## PUBLICATIONS

*Rozman, Č, Pažek, K, Kljajič, M, Bavec, M, Turk, J, Bavec, F, Kofjač, D, Škraba, A:* The Dynamic simulation of organic farming development scenarios: a case study in Slovenia; Computers and Electronics in Agriculture, Vol. 96, No. August (2013), pp. 163–172.

*KOJFAČ, D, ŠKURIČ, M, DRAGOVIČ, B, ŠKRABA, A.* Traffic modelling and performance evaluation in the Kotor cruise port. Strojniški vestnik = Journal of mechanical engineering, Vol. 59, no. 9 (2013), pp. 526–535.

*Clarke, Roger; Pucihar, Andreja (2013).* Electronic interaction research 1988–2012 through the lens of the Bled eConference. Electronic Markets. The International Journal of Networked Business. November 2013. Springer. In press.

*BOHANEČ, M, ŽNIDARŠIČ, M, RAJKOVIČ, V, BRATKO, I, ZUPAN, B.* DEX methodology: three decades of qualitative multi-attribute modeling. Informatica (Ljubljana), 2013, vol. 37, no. 1, str. 49–54.

*PRIJATELJ, V, RAJKOVIČ, V, ŠUŠTERŠIČ, O.* A model for risk assessment in health care using a health care failure method and effect analysis. Zdravstveno varstvo = Slovenian journal of public health. 2013, Vol 52, No. 4, pp. 316–331.

*MALETIČ, D, MALETIČ, M, GOMIŠČEK, B. (2013).* The impact of quality management orientation on maintenance performance. International Journal of Production Research (2013). In press.

## DISSERTATIONS/HABILITATIONS

Dissertations in progress:

*Kristina Bogataj:* Vpliv dejavnikov poslovnega modela ponudnika na uvedbo računalništva v oblaku / Impact of providers business model factors on cloud computing adoption, supervisor: Assist. Prof. Andreja Pucihar, PhD

*Matjaž Kragelj:* Razvoj metodologije za avtomatično klasifikacijo elektronskih publikacij v Univerzalno decimalno klasifikacijo – UDK / Development of methodology for automatic classification of electronic publications in Universal Decimal Classification – UDK, supervisor: Assist. Prof. Mirjana Kljajič Borštnar, PhD

*Igor Korelič:* Adaptivna predstavitev večrazsežnega podatkovnega modela z uporabo metode večkriterijskega odločanja / Adaptive presentation of Multidimensional Data Model Using MultiCriteria Decision Analysis, supervisors: Prof. Emeritus Vladislav Rajkovič, PhD, Assist. Prof. Mirjana Kljajič Borštnar, PhD

*Marjan Breljih:* Model povezovanja kvantitativnega in kvalitativnega modeliranja večkriterijskega znanja / A Model of Quantitative and Qualitative Decision Knowledge Modelling Integration, supervisor: Assist. Prof. Uroš Rajkovič, PhD



## CONTACT DETAILS

**DR. ANDREJA PUCIHAR**

Information Systems Department,  
Faculty of Organizational Sciences

University of Maribor  
Kidričeva cesta 55 a  
4000 Kranj, Slovenia  
P+386 4 374 218  
[www.linkedin.com/in/andrejapucihar](http://www.linkedin.com/in/andrejapucihar)  
[andreja.pucihar@fov.uni-mb.si](mailto:andreja.pucihar@fov.uni-mb.si)

## KEY FACTS

### INSTITUTION

- Employees: 64
- Students: 2 000

### AWARDS

Certificate of Membership in the International Academy of Arts, Sciences and Engineering to Prof. Miroslav Kljajič, for his outstanding scholarly work and his significant life-long contribution to the advancement of Simulation Based Decision Support.



# HIGHER SCHOOL OF ECONOMICS – MOSCOW AND NIZHNY NOVGOROD



## HIGHER SCHOOL OF ECONOMICS MOSCOW

The HSE Moscow, Faculty of Business Informatics is the leading faculty in Russia in research and implementation of information systems in business, software engineering, corporate information systems, and other strategic IT topics. Graduates of the Faculty of Business Informatics are working as business analytics, software architects, are leading IT Departments, and are managing small and medium size companies in the IT area.

### RESEARCH TOPICS

- Social networks research
- Enterprise Architecture and business process management for very large companies
- Business Transformation and organizational change
- Business Process Management
- ERP systems
- Semantic Networks
- Knowledge Management
- E-Business and Internet Technologies
- Data Mining and Decision Support

### INDUSTRY COOPERATION

Traditionally, the faculty of Business Informatics has a very strong link with the IT industry. International and Russian companies are taking an important role as members of the Faculty Advisory Committee and Industry placements. Among them are IBM, SAP, Microsoft, Lanit, IBS, 1, Cognitive Technologies, and others. E.g., SAP Academic Department is working very closely with HSE students as part of Russian and EU projects and is currently implementing different activities for students. Subject of the multilateral relations between HSE Moscow/SAP Academic Department and the industry is the interaction between the commercial organization and the university and its students. This year, the department started to work with students by conducting different business team games and a Design Thinking competition. “We at HSE are very proud to be part of the ERCIS network – a truly leading information systems research network in the World” – Prof. Dr. Svetlana Maltseva, Acting Dean, Faculty of Business Informatics, Higher School of Economics Moscow.

## HIGHER SCHOOL OF ECONOMICS NIZHNY NOVGOROD

The Higher School of Economics in Nizhny Novgorod (HSE NN) was founded in 1996. The main educational activities of the Faculty of Business Informatics and Applied Mathematics (BIAM) of the HSE NN are related to modern enterprise organization, enterprise architecture, business mathematical and computer modeling. The laboratory TAPRADESS (Theory and Practice of Decision Support Systems) is the research unit of the Faculty BIAM.

### RESEARCH TOPICS

The research of the Faculty BIAM and TAPRADESS Laboratory focuses on following directions:

- Cognitive science – the development of methods and techniques of receiving, processing, storage, use and management of professional knowledge
- Situational Modeling – multidimensional modeling of the behavior and decision making processes of individual and collective agents in complex distributed systems.
- Decision Making Analysis: basic approaches for solving important problems like the reengineering of companies using advanced technologies of e-business and a consistent set of formal process-oriented models. This result allows us to effectively conduct a systematic analysis of economic and technological factors affecting the sustainable development of business and e-commerce.
- Original ways of formalizing the knowledge, which are based on ontological engineering, and are supplemented by practical methods of integration and verification of complex corporate service-oriented systems.
- New mathematical models and multi-agent optimization algorithms in distributed service-oriented systems applicable to different domains (transport, planning, training activities); the result defines new approaches to the creation and use of intelligent decision support systems in the modern service-oriented economy.

- Axiomatic approach to non-compensatory aggregation (decision making rules) and axiomatic approach to general measure of power (power indices) in a voting body.

### CURRENT RESEARCH PROJECTS

**Knowledge technologies for improving multi-modal logistics operations in seaports**

The project team performs an analysis of business-processes and information technologies in the framework of modern port logistics operations. The goal of the project is to develop high-level models of adaptive business processes and distributed software implementations using multi-agent technologies. The ontology-based specifications and principles of holonic self-organization are explored at the theoretical level, and JESS multi-agent platform is used for soft-ware prototyping. The project is conducted in co-operation with INSA-Rouen (France).

**Development of the methodology for Value Assessment of SOA-based IS Projects**

This research is aimed at adopting existing IT project assessment methods for measuring the value of SOA-based IS projects. The research considers the fact that SOA-based IS deployment and evolution could be split in separate flows, one per service.

**Development of the adaptive methodology of business process-management for small and medium enterprises in emerging economies**

The research focuses on the investigation of key influencing factors which facilitate innovative development of small and medium-sized enterprises. The project is supported by SAP AG.

## CONTACT DETAILS MOSCOW



**PROF. DR. SVETLANA MALTSEVA**

Acting Dean of Faculty of Business Informatics, Head of the Department of Innovation and Business Technologies, Deputy Director of Institute of Information Technologies

P +7 495 771 32 38  
smaltesva@hse.ru

Higher School of Economics  
Moscow  
Kirpichnaya street, 33/5  
Moscow, 105187  
Russia

[www.bi.hse.ru](http://www.bi.hse.ru)

## CONTACT DETAILS NIZHNY NOVGOROD



**PROF. DR. EDUARD BABKIN**

Laboratory TAPRADESS

P +7 831 416 9536  
eababkin@hse.ru



**PROF. DR. VALERY KALYAGIN**

Faculty of Business Informatics and Applied Mathematics

P +7 831 416 9649  
vkalyagin@hse.ru

Higher School of Economics  
Nizhny Novgorod  
Bolshaya Pecherskaya street, 25/12  
Nizhny Novgorod, 603155  
Russia

[www.hse.ru](http://www.hse.ru)





## ABOUT THE INSTITUTION

Founded in 1870, Stevens is a premier private university focused on research and entrepreneurship in technology-related fields. Located across the Hudson River from Manhattan, in Hoboken, New Jersey, Stevens has a population of 3700 graduate and 2300 undergraduate students. Stevens is committed to exploring the frontiers of engineering, science and management through integrative research and education programs. Three schools and one college support the mission of Stevens: The Charles V. Schaefer Jr. School of Engineering and Science, the Wesley J. Howe School of Technology Management, the School of Systems and Enterprises and the College of Arts and Letters. Businessweek ranked Stevens in the top 3% of U.S. universities based on student return on investment. Notable graduates include Frederick Winslow Taylor, the father of scientific management; Henry Gantt, whose Gantt chart is a staple in most project managers' toolkits; and Alfred Fielding, the inventor of Bubble Wrap.

The Howe School has 40 full-time faculty serving 250 undergraduates, 850 MS students, 100 MBA students, 50 executive master's students, 25 Ph.D students, and numerous non-degree graduate and executive programs. Its Information Systems group is among the largest graduate programs in the U.S., providing instruction to students locally and around the globe.

The Howe School is in the midst of a five-year strategic plan designed to improve the quality of its research by growing its student and faculty population and forging stronger ties to the corporate community. As part of this effort, the school hired six new faculty members who started in the fall. Each brings a strong research background to Stevens. The faculty, and their areas of expertise, are Ricardo Collado, decision making amid risk, and its application in areas such as energy and management science; Hamed Ghoddsi, public policy, asset pricing, investment, and energy and environmental finance; Theodoros Lappas, data mining, machine learning, search algorithms, social media and analytics; Adriana Madzharov, consumer behavior, with a specific interest in sensory marketing; Ying Wu, asset pricing, international finance and financial economics; and Mahmoud Daneshmand, an expert in big data analytics and data mining algorithms.

## RESEARCH TOPICS AND PROJECTS

Within the School of Technology Management, two information systems-related research groups operate in the areas of business process innovation and decision technologies.

**The Center for Decision Technologies (CDT)** researches the networks that can assist in building technologies that augment decision making. The center focuses on two main areas:

**Understanding social network dynamics.** The ubiquitous use of mobile devices to share information through social networks is creating new forms of research to study how ideas are generated and shared within communities. CDT members are examining data from platforms such as Digg and Twitter to discover how social networks can predict political, cultural and economic phenomena, and are exploring new ways of visualizing the data to help decision makers easily identify trends.

**Improving the design of information systems.** Systems are difficult to design, and little is understood about how to encourage the creative leaps that lead to simple, but powerful, designs. CDT members are looking at how diagrams, gesture and language interact in the design process.

**The Center for Business Process Innovation (CEBPI)** researches how process innovation improves organizational performance, and how companies can better manage business process technologies. CEBPI hosts a state-of-the-art business process management technology lab, and hosted the 2010 International Conference on Business Process Management. The center also focuses its research on two distinct areas:

**Semantic enterprise architecture.** Enterprise architecture (EA) helps stakeholders understand, manage and change organizations and their technical infrastructure. For organizations that engage in large architecture projects, a systematic organization of the architecture content is essential.



To date, this has meant choosing either a single modeling framework and language, or sticking to a particular architecture tool. Semantic enterprise architecture uses techniques born out of semantic Web efforts to better understand and analyze the information generated in EA projects, regardless of the tool or method used.

**Emergent processes in standardization organizations.** Standards organizations create specifications that regulate many aspects of commerce and private life — from the way we connect peripherals to our laptops to the way health insurers and hospitals share information. While the adoption of standards has been subject to some scrutiny, the development of standards has received much less attention. CEBPI members are studying the collaboration patterns of standards makers in the development of new Web standards. We seek to explain how those decision makers create standards, as well as the factors that impact the effectiveness of the standardization process.

## PUBLICATIONS

*Genc, Y., Lennon, E. A., Mason, W., & Nickerson, J. V. (2013).* Building Ontologies from Collaborative Knowledge Bases to Search and Interpret Multilingual Corpora. *ACL 2013*, 87.

*Kitur, A., Nickerson, J. V., Bernstein, M., Gerber, E., Shaw, A., Zimmerman, J., Horton, J. (2013).* The future of crowd work. In *Proceedings of the 2013 conference on Computer supported cooperative work* (pp. 1301–1318).

*Nickerson, J. V., Corter, J. E., Tversky, B., Rho, Y.-J., Zahner, D., & Yu, L. (2013).* Cognitive tools shape thought: diagrams in design. *Cognitive processing*, 1–18.

*Yu, L., & Nickerson, J. V. (2013).* An internet-scale idea generation system. *ACM Transactions on Interactive Intelligent Systems (TiIS)*, 3(1), 2.

*Mason, W., & Clauset, A. (2013a).* Friends ftw! friendship and competition in halo: Reach. In *Proceedings of the 2013 conference on Computer supported cooperative work* (pp. 375–386).

*Lappas, T., Vieira, M. R., Gunopulos, D., & Tsotras, V. J. (2013).* STEM: a spatio-temporal miner for bursty activity. In *Proceedings of the 2013 ACM SIGMOD International Conference on Management of Data* (pp. 1021–1024). New York, NY,

*Zhang, K., Jin, Q., Pelechrinis, K., & Lappas, T. (2013).* On the importance of temporal dynamics in modeling urban activity. In *Proceedings of the 2nd ACM SIGKDD International Workshop on Urban Computing* (pp. 7:1–7:8). New York, NY, USA

*zur Muehlen, M., & Recker, J. (2013).* "We still don't know how much BPMN is enough — but we are getting closer.", *Seminal Contributions to Information Systems Engineering*. In Bubenko, J.; Krogstie, J.; Pastor, O.; Pernici, B.; Rolland, C.; Solvberg, A., Springer (pp. 445–452).



## CONTACT DETAILS

### PROF. DR. MICHAEL ZUR MUEHLEN

Howe School of Technology Management  
Stevens Institute of Technology  
Castle Point on Hudson  
Hoboken, New Jersey 07030  
United States of America  
p +1 201 216 8293  
[stevens.edu/howe](http://stevens.edu/howe)  
[michael.zurmuehlen@stevens.edu](mailto:michael.zurmuehlen@stevens.edu)

### INSTITUTION

- 40 full-time faculty
- 250 undergraduate students
- 1000 masters and MBA students
- 25 Ph.D students

### RESEARCH TOPICS

- Semantic enterprise architecture
- Standardization development
- Information systems design
- Social network dynamics
- Business intelligence and analytics
- Process innovation

### AWARDS

- Ranked in the top 100 among U.S. universities (U.S. News & World Report)
- Ranked in the top 3% for student ROI for U.S. universities (Businessweek)
- Hoboken ranked 12<sup>th</sup>-best college town in the United States (Princeton Review)
- Stevens WebCampus platform



# CHARLES UNIVERSITY IN PRAGUE – FACULTY OF MATHEMATICS AND PHYSICS – DEPARTMENT OF SOFTWARE ENGINEERING

› Charles University in Prague, Faculty of Mathematics and Physics – Department of Software Engineering [www.ksi.mff.cuni.cz](http://www.ksi.mff.cuni.cz)



## ABOUT THE INSTITUTION

The School of Computer Science at the Faculty of Mathematics and Physics of the Charles University includes seven prestigious teaching and scientific programmes. The Faculty of Mathematics and Physics was separated from the Faculty of Natural Sciences September 1st, 1952 and is currently composed of the School of Physics, School of Mathematics, and School of Computer Science. The Faculty of Natural Sciences, in turn, was established in 1348 together with the foundation of the Charles University.

The graduates of the School of Computer Science are widely recognized by companies. Most of them work as software developers and technological innovators. Some of the graduates became successful entrepreneurs. Members of the School of Computer Science achieve outstanding scientific results in such fields as discrete mathematics (with the focus on graph theory and its application in intelligent systems), optimization, programming methods, building large software systems and analysis of their semantics, as well as processing of natural language.

The Department of Software Engineering is focused on research and teaching in the areas of database systems, semantic web, similarity search, XML technologies, parallel computing, and e-Science.



## RESEARCH TOPICS

There are four research groups at the Department of Software Engineering:

### - Web Semantization Research Group (SeMWeX)

SeMWeX was informally founded in 2008 as a result of numerous seminars on topics related to semantization technologies. Semantization is a process of increasing the degree of automation in web processing. SemWeX goal is to do research on and develop the idea of global semantization. The areas of research interest of the SemWeX members include information extraction, semantic repository, querying adjusted to user preferences, experimental evaluation of formal and theoretic results, prototype development and proofs of concepts. These research areas are aimed to be interconnected within SeMWeX. For further information please visit [www.ksi.mff.cuni.cz/semwex](http://www.ksi.mff.cuni.cz/semwex)

### - Similarity RETrieval Research Group (SiRet)

SiRet was founded in 2006 and is aimed at dealing with database methods for efficient and effective similarity search in databases of complex unstructured objects. In particular, SiRet is focused on such areas

as general methods of indexing similarity (metric and non-metric spaces), biological applications of similarity search, and indexing image databases for content-based retrieval. For further information please visit <http://siret.ms.mff.cuni.cz>

### - XML and Web Technologies Research Group (XRG)

XRG focuses on XML and Web technologies and their exploitation, service-oriented architectures (design, implementation, management), evolution, change management and adaptability of applications, efficient processing of graph data, ontologies, and semantic web services. Research focus of XRG has recently been extended in accordance with the Opendata.cz initiative and currently also includes linked data research, dataset creation, graph databases and data provenance. For further information please visit [www.ksi.mff.cuni.cz/xrg](http://www.ksi.mff.cuni.cz/xrg)

### - Parallel Architectures/Algorithms/Applications Research Group (PARG)

PARG was officially founded in 2013, although individual research of the group members began much earlier. The group is formed by the researchers and PhD students from the Department of Software Engineering. The PARG research activities and

topics of interest include multi-core CPUs and NUMA servers, many-core GPUs and GPGPU computing, emerging parallel architectures (Intel MIC, Parallela/Epiphany), distributed computing on tightly coupled clusters, parallel data processing and concurrency in database systems, as well as languages (and compilers) for parallel processing. For further information please visit [www.ksi.mff.cuni.cz/parg](http://www.ksi.mff.cuni.cz/parg)

## CURRENT RESEARCH PROJECTS

The department members are involved in a number of research projects funded by the Czech Science Foundation and the Grant Agency of Charles University: Intelligent library – INTLIB, Non-Metric Similarity Searching in Very Large Complex Databases. Conceptual Modelling of XML, Efficient Processing of Linked Data, Parallel processing of finite data stream, Architecture for Trusted Linked Data, Highly Scalable Parallel and Distributed Methods of Data Processing in e-Science, Synergistic Modelling of Adaptive Similarities for Multimedia Retrieval, Large-scale Nonmetric Similarity Search in Complex Domains. The project Finding similar events within IDS is supported by CISCO.

## PUBLICATIONS

*Bartoš T.*: Universal Indexing of Arbitrary Similarity Models, VLDB Endowment, Vol. 6, No. 12., Riva del Garda, Trento, Italy, VLDB Endowment, 2013

*Pokorný J.*: NoSQL Databases: a step to database scalability in Web environment., in International Journal of Web Information Systems, Vol. 9, Num. 1, pp. 69–82, 2013

*Peška L., Lašek I., Eckhardt A., Dědek J., Vojtáš P., Dominik F.*: Towards web semantization and user understanding, in Frontiers in Artificial Intelligence and Applications, Vol. 251, pp. 63–81, 2013

*Novák J., Sachsenberg T., Hoksza D., Skopal T., Kohlbacher O.*: On Comparison of SimTandem with State-of-the-Art Peptide Identification Tools, Efficiency of Precursor Mass Filter and Dealing with Variable Modifications, in Journal of Integrative Bioinformatics, Vol. 10, No. 3, 2013

*Malý J., Nečaský M.*: When Grammars do not Suffice: Data and Content Integrity Constraints Verification in XML through a Conceptual Model, in Proceedings of the 9<sup>th</sup> Asia Pacific Conference on Conceptual Modeling, Adelaide, Australia, Australian Computer Society, Inc., pp. 21–30, 2013

*Falt Z., Čermák M., Zavoral F.*: Highly Scalable Sort-Merge Join Algorithm for RDF Querying, in Proceedings of the International Conference on Data Technologies and Applications, Joaquim Filipe, et al. (Eds.), Reykjavik, Island, SCITEPRESS, Portugal, 2013

*Chytil M., Polák M., Holubová I., Nečaský M.*: Evolution of a Relational Schema and its Impact on SQL Queries, in Proceedings of the 7<sup>th</sup> International Symposium on Intelligent Distributed Computing, IDC 2013, Prague, Czech Republic, Springer International Publishing, Prague, Springer, pp. 5-15, 2014

*Kopecký M., Pokorný J., Vojtáš P., Kubalík J., Matoušek K., Maryška M., Novotný O., Peška L.*: Testing and Evaluating Software in a Social Network Creating Baseline Knowledge, in Frontiers in Artificial Intelligence and Applications, Vol. 251, pp. 127–141, 2013

## DISSERTATIONS

*Marin Krulis*: Employing Parallel Architectures in Similarity Search

*Matus Ondreicka*: Preference Top-k Search Based on Multimedia B-Tree

*Jakub Klimek*: XML Formats Evolution and Integration

*Jiri Novak*: Similarity Search in Mass Spectra Databases



## CONTACT DETAILS

### PROF. JAROSLAV POKORNÝ

Department of Software Engineering

Charles University in Prague  
Malostranske nam. 25  
118 00 Prague, Czech Republic  
P +420 221 914265  
[www.ksi.mff.cuni.cz](http://www.ksi.mff.cuni.cz)  
[pokorny@ksi.mff.cuni.cz](mailto:pokorny@ksi.mff.cuni.cz)

## KEY FACTS

### INSTITUTION

- University founded in 1348
- Faculty founded in 1952
- Department founded in 1993
- 2 full professors
- 2 associate professors
- 4 assistant professors
- 3 researchers
- 16 PhD students

### RESEARCH TOPICS

- Database systems
- Semantic web
- Similarity search
- XML
- Parallel computing

### EVENTS

- 7<sup>th</sup> International Symposium on Intelligent Distributed Computing – IDC'2013 took place September 4<sup>th</sup>–6<sup>th</sup>, 2013 in Prague.





## ABOUT THE INSTITUTION

The Research Center on Information Systems (CeRSI) is the unit of the LUISS Guido Carli University in charge of both base and applied research in the areas of information systems (IS), enterprise software and knowledge platforms, organization studies, and information and communication technologies. CeRSI regularly runs scientific research and consultancy activities, and participate to national, European, and international R&D programs. CeRSI also promotes the development of research in cooperation with most prominent Italian and foreign scientific communities, and performs, upon request by public or private, national or international, organizations, scientific counselling and researches in the aforementioned thematic areas.

CeRSI is one amongst the most relevant research centers in the area of IS in Italy, not only for the quality of the research activities performed, but also for having contributed to the birth and to the growth of the *itAIS* ([www.itais.org](http://www.itais.org)), the Italian Chapter of the AIS ([www.aisnet.org](http://www.aisnet.org)), and for having promoted and coordinated the role of the Italian academic and scientific community, especially at an international level. In the international landscape, even though it cannot compete with institutions with a more large and solid experience, CeRSI is credited of a relevant position achieved mainly thanks to the participation to a high number of international research projects, the agreements on scientific cooperation, and the contributions to the organization of several international events.

In 2013 the CeRSI research center has hosted, for visiting or seminars: Ole Hanseth (University of Oslo), Gwanhoo Lee (American University), Susanne Leist (University of Regensburg), Øystein Sæbø (University of Agder), Armin Stein (University of Münster), Robert Winter (University of St. Gallen). Still in 2013 members of the CeRSI research center joined the following foreign Universities as visiting scholars: the Department of Information Systems of the University of Agder (Kristiansand, NO), the Department of Informatics of the University of Oslo (Oslo, NO), the Department of Management of the Monash University (Melbourne, AUS), the People, Management and Organisations unit of the Manchester Business School (Manchester, UK).

## RESEARCH TOPICS

Research at CeRSI is done in conjunction with project activities in which CeRSI members participate in the iterative phases of designing and evaluating IT artefacts. A multidisciplinary team of IS scholars with backgrounds in computer science, engineering, economics, management, cognitive and political sciences collaborate in both project and research activities by bringing together a multiplicity of methods for planning interventions and analyzing phenomena from different perspectives. This approach allows addressing relevant problems and engaging in national and international cooperation with other universities and research institutions.

Research at CeRSI focuses on three subject areas. The first is related to innova-

tive forms of collaborative environments in which IT has the potential to influence the dynamics of complex adaptive systems. The second is related to organizational learning processes and capability development. The third refers to IT governance models, methods and tools in relationship with the evolution of socio-technical systems. Among the more recent application domains for these concepts are e-Health and social services, e-business, and e-participation.

## CURRENT RESEARCH PROJECTS

In 2013 the following research projects contributed by CeRSI came to a successful conclusion:

- HOPES – Help and social interaction for elderly On a multimedia Platform with E-Social best practices (<http://www.hopes-project.org/>)
- MID-BLUE – Multimedia Information Distribution Using Bluetooth, financed by the Regional Law (Lazio)
- LiVES – Learning in Virtual Extended Spaces, financed by the Regional Law (Lazio)

Six studies were started by CeRSI in 2013 and many of them are follow ups of the above mentioned projects:

- A comparative study on the evolution of patient centered welfare strategies in Italy and Norway (in collaboration with the University of Oslo);
- A study on the ethical issues of emerging forms of online collaboration for business and collective decision making (in partnership with Provincia di Roma, Legacoop, and the Department of Political Science of the LUISS Guido Carli University);

- A study on innovative lifelong learning models based on digital platforms and applications (in collaboration with Monash University);
  - A study on the e-leadership curricula in Italian business schools (in partnership with AICA);
  - A study on the accountability in IT projects (in partnership with Forum delle Competenze Digitali and INFORAV);
  - A study on agent based model simulation of complex socio-technical systems.
- Around these studies 10 project proposals were submitted for EU funding, and three of them are still under evaluation.

In 2013 CeRSI organized the annual conference of the Italian Chapter of AIS. The conference took place at the Luigi Bocconi University in Milan on December 14<sup>th</sup> as an official ancillary event of ICIS. Moreover CeRSI also organized the 9<sup>th</sup> edition of ALPIS and is actively involved in the organization of forthcoming ALPIS 2014 edition, of the 2014 annual ERCIS workshop, and the 4<sup>th</sup> Organizations, Artifacts and Practices (OAP) Workshop that will take place at LUISS in June 2014.

In 2013 Springer published the two volumes of the series Lecture Notes in Computer Science and Information Systems (LNISO), started by the CeRSI in 2012 with a volume in memory of Prof. Alessandro D'Atri. Three additional volumes linked to the ItAIS 2013 conference are under production and will be issued in 2014.

In 2013 the ERCIS network constituted an important vehicle of opportunities for CeRSI, being the main source of contacts for scholar exchanges and joint research activities and by getting the center involved in two EU project proposals

## PUBLICATIONS

*Baskerville, R., De Marco, M., Spagnoletti, P. (Eds.) (2013).* Designing Organizational Systems – An Interdisciplinary Discourse. Lecture Notes in Information Systems and Organisation (1), Springer. (introduction downloadable for free at [www.itais.org](http://www.itais.org)).

*Spagnoletti, P. (Ed.) (2013).* Organizational Change and Information Systems – Working and Living Together in New Ways. Lecture Notes in Information Systems and Organisation (2), Springer.

*Vom Brocke, J., Braccini, A. M., Sonnenberg, C., & Spagnoletti, P.* Living IT Infrastructures – An Ontology-based Approach to Aligning IT Infrastructure Capacity and Business Needs (forthcoming). International Journal of Accounting Information Systems, doi:10.1016/j.accinf.2013.10.004.

*Resca A., Za S. and Spagnoletti P. (2013).* Digital Platforms as Sources for Organizational and Strategic Transformation: A Case Study of the Midblue Project, Journal of Theoretical and Applied Electronic Commerce Research, Vol. 8, No. 2, pp. 71–84.

*Marzo F., Za S., Spagnoletti P. (2013).* Modeling dependence networks for agent based simulation of online and offline communities. In Advances in Practical Applications of Agent and Multi-Agent Systems, Demazeau Y. et al. (Eds.), LNCS, vol. 7879, pp. 192–203, Springer.

*Winter R., Spagnoletti P., Za S. (2013).* Exploring Foundations for Using Simulations in IS Research, International Conference on Information Systems, Milan 15–18 December, Italy.

*Braccini, A.M. & Federici, T. (2013).* A Measurement Model For Investigating Digital Natives And Their Organisational Behaviour, International Conference on Information Systems, Milan 15–18 December, Italy.

*Sabini, L., (2013)* A story of professionalization, 10th Conference of the Italian Chapter of AIS, Milan 15–18 December, Italy.

*Sæbø, Ø., Braccini, A. M., Federici, T. (2013).* From the Blogosphere into Real Politics: The Use of ICT by the Five Star Movement, 10th Conference of the Italian Chapter of AIS, Milan 15–18 December, Italy.



## CONTACT DETAILS

**DR. PAOLO SPAGNOLETTI**  
CERSI – Research Center for Information Systems

Luiss Guido Carli University  
via T. Salvini 2  
00197 Roma, Italy  
P +39 06 85225795  
[www.cersi.it](http://www.cersi.it)  
[pspagnoletti@luiss.it](mailto:pspagnoletti@luiss.it)

## KEY FACTS

### INSTITUTION

- Amongst the most relevant research institutions in the IS research area in Italy
- 4 senior advisors
- 5 researchers
- 1 PhD student
- Several external national and international co-workers

### RESEARCH TOPICS

- Cooperative environments
- Organizational learning processes
- IT governance models, methods and tools

### EVENTS

- 9<sup>th</sup> ALPIS Seminar, Carisolo (TN), February 2013
- X Conference of the Italian Chapter of AIS, Milan, December 2013





## ABOUT THE INSTITUTION

The Institute of Information Management at the University of St. Gallen (IWI-HSG), founded in 1989, is an autonomous research institution affiliated to the University of St. Gallen (HSG). The Institute pursues a mixed funding approach. Both public and privately funded research projects at the IWI-HSG are organized within the research program “Business Engineering”, which focuses on supporting business transformation (the “Change the Business” concept) through engineered generic artefacts, such as e.g. methods. Employing the Competence Centre (CC) approach for its main research topics, the IWI-HSG coordinates and moderates several companies in developing an innovative solution approach to important and relevant design problems in information management.

The Institute of Information Management is comprised of six departments run by six full professors: Andrea Back, Walter Brenner, Reinhard Jung, Jan Marco Leimeister (temporary position), Hubert Österle, and Robert Winter. Eleven postdocs, ca. 35 PhD students, ca. 15 other support staff and several student assistants work at the Institute.

## RESEARCH TOPICS AND CURRENT

### RESEARCH PROJECTS

**Enterprise Transformation Management:** The main research focus of the CC Corporate Intelligence is “A Design Theory for Architectural Coordination of Enterprise Transformations” project. In this project a theoretically grounded and customized methodology for a coordinated implementation of enterprise transformation is developed. For this purpose, various architectural elements, such as frameworks, modelling languages or model analysis, are integrated in a consortium of industry partners. For further information please visit <http://ci.iwi.unisg.ch>

**Corporate Data Quality:** The CC Corporate Data Quality is focused on the development of methods, architectures, reference models, and prototypes required for efficient implementation of Corporate Data Quality Management (CDQM) in organizations. During consortium workshops and bilateral projects participating enterprises gain critical know-how on successful establishment and maintenance of highly effective CDQM systems. For further information please visit <http://cdq.iwi.unisg.ch>

**Health Services Research:** The CC Health Network Engineering focuses on optimization of business processes in healthcare organizations, as well as on networkability within the public health sector. Current research topics include transformational health care and e-Health, process and quality management in health care, cooperation and service engineering, as well as

business models in the public sector. Furthermore, a project together with the ETH Zürich and the Swiss air traffic control was launched to develop business models for the harmonization of air navigation systems in Swiss airspace security. For further information please visit <http://ehealth.iwi.unisg.ch>

**IT Management:** The CC Information Management addresses current and future challenges of Information Systems Management. Research activities include IT outsourcing strategies, group IT controlling, and organizational agility for application development.

**Process & Systems Design:** The CC Industrial Services and Enterprise Systems focuses on the design of processes, systems and data structures for service operations management in the manufacturing industry. Research activities include installed base management, remote service, mobile workforce management, and service analytics.

**Design Thinking:** The Design Thinking research group is focused on embedding human-centric innovation tools into corporate structures. The research team continuously strives to improve the capability of corporate IT in order to innovate using a holistic approach and to reduce costs and risks in innovation projects. Recent research findings have proved that a combination of verified tools with new agile processes and methods in organizations initiate the transformation towards customer-oriented IT.

**Service Innovation & Engineering:** The Service Innovation and Engineering group contributes to a use- and context-centric full lifecycle approach to design, engineering, and management of complex services. The goals of the research group include addressing the challenge of integration of knowledge in the following areas: context and use, functional and constructive service views, as well as innovation, engineering and management activities along the service lifecycle.

**Sourcing in Financial Services:** The CC Sourcing (in cooperation with the University of Leipzig) develops concepts, instruments and prototypes for managing financial networks. Research activities concentrate on customer- and service-oriented innovations in networked banks. For further information please visit <http://sourcing.iwi.unisg.ch>

**Independent Living:** The CC Independent Living is engaged in research topics related to quality of life enhancement with a special focus on elderly citizens. Besides working on innovative service solutions (e.g. outdoor and safety assistants on mobile devices), service marketplaces and corresponding business models, which facilitate local service provider networks to serve consumers with personalized well-coordinated service bundles, are developed and tested. For further information please visit <http://il.iwi.unisg.ch>

**Mobile Business Solutions:** The competence network Business 2.0 and the CC Mobile Business conduct applied research in the fields of social and mobile business. The group works in close cooperation with partners from various industries to facilitate knowledge transfer among practitioners. For further information please visit <http://aback.iwi.unisg.ch>

## PUBLICATIONS

The following list represents a very limited extract of the IWI-HSG publications in 2013. A complete list of publications, as well as full texts of many papers, is available at <http://www.iwi.unisg.ch/publikationen>

**Aier, Stephan:** Understanding the Role of Organizational Culture for Design and Success of Enterprise Architecture Management, Alt, R., Franczyk, B. (Eds.): Proceedings of the 11<sup>th</sup> International Conference on Wirtschaftsinformatik (WI 2013), Leipzig, 27.02.2013, Leipzig, 1, 2013, pp. 879–894.

**Blohm, Ivo; Leimeister, Jan Marco:** Gamification. Gestaltung IT-basierter Zusatzdienstleistungen zur Motivationsunterstützung und Verhaltensänderung. In: WIRTSCHAFTSINFORMATIK. 55 (2013), Nr. 4, S. 275–278

**Fischbach, Michael; Puschmann, Thomas; Alt, Rainer:** Service Lifecycle Management, In: Business & Information Systems Engineering, 55 (2013), 1, S. 51–55.

**Gebauer, Lysann; Söllner, Matthias & Leimeister, Jan Marco:** Towards Understanding the Formation of Continuous IT Use. To appear in Proc. ICIS 2013.

**Jung, Reinhard (Hrsg.); Reichert, Manfred (Hrsg.):** Enterprise Modelling and Information Systems Architectures: Proceedings of the 5<sup>th</sup> International Workshop on Enterprise Modelling and Information Systems Architectures, EMISA 2013, Lecture Notes in Informatics. Bonn: Köllen, 2013.

**Sammer, Thomas; Brechbühl, Hans; Back, Andrea:** The New Enterprise Mobility: Seizing the Opportunities and Challenges in Corporate Mobile IT. In: Proceedings of the 19<sup>th</sup> Americas Conference on Information Systems (AMCIS 2013)

**Terlouw, Linda; Albani, Antonia:** An Enterprise Ontology-Based Approach to Service Specification. In: IEEE Transactions on Services Computing 6 (2013), Nr. 1, pp. 89–101.

**Weiss, S., Aier, S., Winter, R.:** Institutionalization and the Effectiveness of Enterprise Architecture Management, to appear in Proc. ICIS 2013

## EVENTS

The Anwenderforum St. Gallen events are held three times a year. The 38<sup>th</sup>, 39<sup>th</sup> and 40<sup>th</sup> editions took place in 2013. The Forum topics alternate between enterprise transformation, business analytics and use-centric IT. IWI-HSG also organizes the Business Engineering Forum, the IT Operations Days and the Mobile Business Forum.



## CONTACT DETAILS

**PROF. DR. ROBERT WINTER**  
Institute of Information Management

University of St. Gallen  
Mueller-Friedberg-Strasse 8  
9000 St. Gallen, Switzerland  
P +41 71 2242190  
[www.iwi.unisg.ch](http://www.iwi.unisg.ch)  
[robert.winter@unisg.ch](mailto:robert.winter@unisg.ch)

## KEY FACTS

### INSTITUTION

- Founded in 1989
- 6 Chairs
- 50 Researchers
- Executive Education
- Programs: Executive Master in Business Engineering, Diploma in IT Business Management

### RESEARCH TOPICS

- Enterprise Transformation Management
- Corporate Data Quality
- Health Services Research
- IT Management
- Process & Systems Design
- Design Thinking
- Service Innovation and Engineering
- Sourcing in Financial Services
- Independent Living
- Mobile Business Solutions



# UNIVERSITY OF TURKU – TURKU SCHOOL OF ECONOMICS – DEPARTMENT INFORMATION SYSTEMS SCIENCE

› University of Turku – Turku School of Economics – Department Information Systems Science [www.utu.fi/tse-en](http://www.utu.fi/tse-en)



## ABOUT THE INSTITUTION

The University of Turku is a multidisciplinary scientific university located on the Southwest coast of Finland, in the vivid student city of Turku. With over 23 000 students and 3 500 employees, University of Turku is one of the largest universities in Finland. The Institute for Information Systems has three full professors and a total staff of about 25 and has approximately 20 active doctoral level students. The yearly intake for students to the bachelor level having information systems science as their major subject is around 15 of the annual intake of 250 of the whole Business School. In addition there are yearly approximately 40 master level students in the two international master programs of the Institute: Global Information Systems Management and International Master in Management of Information Technology. Information systems is a popular minor for students of many areas of economics, business administration as well as computer science.

The Institute is a member of Turku Center for Computer Science (TUCS) for studies within information systems. TUCS is a joint unit between University of Turku, the Turku-based Swedish-speaking Åbo Akademi University and Turku Polytechnics. All master level courses within TUCS are taught in English. The Institute for Advanced Management Systems Research (IAMSR) in Åbo Akademi University and Information Systems Science in Turku School of Economics has formed Turku Information Systems Research Alliance (TISRA). The objective is

to increase the effectiveness and credibility of teaching and research of information systems science on the national level and develop further cooperation and trust between the research units.

## RESEARCH TOPICS

The focus of the research activities within the institute lies within understanding the utilization of information and communication technology in enterprises and other organizations. The research conducted within the institute covers most of the key areas of information systems. The research activities can be classified into four themes:

- Management of Information Systems and Business Information Systems
- Networks and Business Models
- Work Informatics
- Healthcare Information Systems

In terms of research methods used, the institute has a track-record and long traditions of conducting action research dating back to the 1980's. Today, the competence of the faculty members covers the whole methodological spectrum from qualitative to quantitative research.

Despite being in a business school, the Institute runs a rich research tradition on public sector and third sector organizations also. E-health is a good example of this, where the role of public service cannot be forgotten. Research is done from the viewpoint of different organizational stakeholders: organization's top management, information systems management, as well as individuals such as customers or

workers. Recent developments put emphasis on the management and organizational aspects of data security and privacy, as well as IT governance issues.

## CURRENT RESEARCH PROJECTS

During year 2013 the research portfolio of the Institute has remained wide and rich. Research is characterized to be done in rather small projects, but in a wide spectrum. Typically research is centered around individual doctoral students research work, and these works are conceptually grouped to bigger entities.

In co-operation with the Finnish Information Processing Association the Finnish ICT-barometer was again constructed in year 2013. With the development of a master program in information security, research on the topic has also been intensified. A key topic for the institute is business continuance management, both from the market success and information security point of views. Usage of open source platforms and related social network analysis have also found their way to the research portfolio of the institute. Agile use and development of information technology is also strongly on the research agenda.

New research topics include areas such as waste management, healthcare logistics, bridging of digital divide and information technology usage by disabled people (disability divide). Wide research activity on electronic commerce, government, health and tourism continued during the year. Social media usage in different setting is also strongly on the research agenda.

## EVENTS

ICEC 2013 The 15<sup>th</sup> International Conference on Electronic Commerce

The theme of ICEC 2013 was Effective, Agile and Trusted eServices Co-creation. The theme reflected alignment between computerized, formalized business procedures with the need for innovating business genuinely on the-spot, or ad-hoc, to the needs of a customer.

## OUTLOOK

University of Turku has taken over the organization responsibility of the traditional Kilpisjärvi Information Technology Seminar (KISS), run by university of Oulu since 1990's. The meeting always takes place at Kilpisjärvi Biological Station, and is an invitation-only seminar for discussing on doctoral student work. For the year 2014, the KISS seminar is set as a main event even for the whole ERCIS networks.

In August 2014 the fifth International Conference Well-being in the information society (WIS 2014) will take place. The actual topic of the conference 2014 is "Safe and secure cities". In the conference, among other issues secure and equal use of information resources, safe and secure work and education institutions, cyberaggression and cybersecurity and well as impact of culture on urban safety and security will be discussed.

## PUBLICATIONS

*Tarkkanen, Kimmo - Reijonen, Pekka - Tétard, Franck - Harkke, Ville (2013)*. Back to User-Centered Usability Testing. Human Factors in Computing and Informatics Lecture Notes in Computer Science Volume 7946, 2013, pp 91–106.

*A.K.M. Najmul Islam*, Investigating E-learning System Usage Outcomes in the University Context. Computers and Education 69, 387–399, 2013.

*Matti Mäntymäki, A.K.M. Najmul Islam*, Continued Social Virtual World Use among Teens: Examining the Moderating Role of Perceived Network Exposure. In: R. H. Jr. Sprague (Ed.), Hawaii International Con-

ference on System Sciences, 3252–3261, IEEE, 2013.

*Marko Niemimaa, Elina Laaksonen, Dan Harnesk*, Interpreting Information Security Policy Outcomes: A Frames of Reference Perspective. In: 46<sup>th</sup> Hawaii International Conference on System Sciences, 4541–4550, IEEE Computer & Society, 2013.

*Anne-Marie Tuikka, Sami Hyrynsalmi, Kai K. Kimppa, Arho Suominen*, Challenges in Entering Application Markets among Software Producers in Developing Countries. In: Terrell Ward Bynum, William Fleishman, Anne Gerdes, Gitte Møldrup Nielsen, Simon Rogerson (Eds.), The possibilities of ethical ICT, 478–487, Print & Sign University of Southern Denmark, 2013.

*Li, Hongxiu - Liu, Jong - Suomi, Reima*. Exploring the factors motivating e-service users' WOM behaviour. International Journal of Services Technology and Management Vol. 19, Nos 4/5/6, 187–200.

*Tuikka, Anne-Marie - Sachdeva, Neeraj - Suomi, Reima*. Digital disability divide in information society: the case of impairments. Proceedings of Ethicomp 2013. Kolding, Denmark, 12–14 June 2013.

*Fang Xu - Reima Suomi - Wen Shen*. Users' Continuance Intention of a Mobile Check-In Service in China. In Li, Hongxiu, - Järveläinen, Jonna (editors) Effective, Agile and Trusted eServices Co-operation. Proceedings of the 15<sup>th</sup> International Conference on Electronic Commerce ICEC 2013. Turku, Finland, 13–15 of August 2013, Turku, Finland, 171–183.

## DISSERTATIONS

*Merikivi Jani*: Still believing in virtual worlds: A decomposed approach. This dissertation studies the virtual social world of Habbo. It found that youth visit the Habbo world for entertainment and playful elements, but not so much for social connections. The defence was based on a survey among 3 000 Finnish Habbo users.



## CONTACT DETAILS

**PROF. REIMA SUOMI**  
Department Information Systems Science

University of Turku  
Rehtorinpellonkatu 3,  
20520 Turku, Finland  
P +358 50 410 2282  
[www.utu.fi/tse-en](http://www.utu.fi/tse-en)  
[reima.suomi@utu.fi](mailto:reima.suomi@utu.fi)

## KEY FACTS

### INSTITUTION

- International environment
- Approximately 23 000 students
- Circa 3 500 staff members
- Yearly master level intake around 40
- 3 professors
- Circa 25 staff members
- Some 20 active doctoral students

### IS MASTER PROGRAMS

- Global Information Technology Management (GITM)
- International Master in Management of Information Technology (IMMIT)

### RESEARCH TOPICS

- Management of IS and Business Information Systems
- Networks and Business Models
- Work Informatics
- Wellbeing and Healthcare IS



# ULSAN NATIONAL INSTITUTE OF SCIENCE AND TECHNOLOGY (UNIST) – SCHOOL OF TECHNOLOGY MANAGEMENT



## THE ULSAN NATIONAL INSTITUTE OF SCIENCE AND TECHNOLOGY

The Ulsan National Institute of Science and Technology (UNIST) was founded in 2009 with the goal to become not only one of the most prominent national universities in South Korea, but also one of the leading global science and technology universities. UNIST is located in Ulsan, a metropolitan city and the capital of Korean automotive, ship building and petrochemical industries. UNIST fulfils its potential by emerging as a hub of industry-academic cooperation in advanced technologies.

Since the opening of its top-class eco-friendly campus in March 2009, UNIST has been carving out a niche as a world leading university in science and technology. This goal is being achieved by an exceptionally high level education and by focusing on advanced and interdisciplinary research, in particular, in the area of “green” technologies. A strong emphasis on research at UNIST resulted in publications of its professors and research assistants in such top scientific journals as Nature, Science, and Cell.



Not only scientific discoveries are encouraged at UNIST, but also practical application of this knowledge. For instance, cathodic materials, which are commonly found within secondary cells, are now being developed at UNIST, which decreases Korean import costs by up to US \$100 million annually.

Two research centres have recently been established at UNIST focusing on revolutionary ideas and research. The Hans Scholer Stem Cell Research Center was launched jointly with the Max Planck Institute for Molecular Biomedicine. The center is striving to advance stem cell research, as well as application of stem cells to medical issues. Dr. Novoselov from the University of Manchester (UK) who became a 2010 Nobel Laureate in Physics is an honorary director of the second centre, the Graphene Research Center. This center is focused on investigation of the nature of graphene and its derivatives on an atomic level, as well as exploration of the areas, where this “dream material” can be applied.

UNIST is currently the only university in Korea with 100% of lectures held in English, which supports the university goal to become one the world leading universities. Students from more than 30 countries study at UNIST and each year the amount of foreign students increases. We are certain that the advanced curriculum and discussion-oriented lectures offered at UNIST will help to best develop the abilities of all our students! In addition to that, strong partnership programmes with a number of top foreign and domestic institutions have been established by UNIST to promote its education and research activities.



## THE SCHOOL OF TECHNOLOGY MANAGEMENT

The School of Technology Management is aimed at cultivating students who have key talents required in management positions and who will be able to lead the global economy era by combining science and technology principles with managerial skills. Within our undergraduate curriculum students obtain basic knowledge needed to be outstanding managers in a variety of positions. The school offers the following majors: technology management, Management Information Systems, financing, accounting, marketing, and international management. Furthermore, the entrepreneurship course gives students an opportunity to gain knowledge on converting advanced technologies based on research into businesses solutions. This course is important for students who specialize in both the technology management and the engineering fields.

The School of Technology Management has around 420 students, as well as thirty faculty members who make important contributions to research and actively publish results of their work. The school is dedicated to collaboration with leading industries in Ulsan, global internship opportunities for students and international student and faculty exchange programmes with universities worldwide are strongly encouraged. The school strives to provide outstanding education programmes, as well as forefront research facilities agile to continuously changing market and global economy. The graduates of the School of Technology Management are equipped with the capabilities to compete with the global brain powers in international corporations, research centres and universities.

## BUSINESS ANALYTICS PROGRAM

Business Analytics (BA) graduate program was developed at the School of Technology Management to meet the demands set by world trends and local industries. A top-quality curriculum has been developed and eminent professors, as well as active and former business professionals are involved in the BA program. The Program contributes to the strengthening of competitiveness of South Korea and its industries. Within the BA program the students are trained for careers in a variety of business fields. They acquire the up-to-date analytical techniques and business knowledge and can become analytic experts good at analysing and interpreting business phenomena. The BA program consists of business knowledge courses, analytical technique training, and an analytic project. The Program helps students to gain insight into business complexity in the big data age.



# ULSAN NATIONAL INSTITUTE OF SCIENCE AND TECHNOLOGY (UNIST) – SCHOOL OF TECHNOLOGY MANAGEMENT



## RESEARCH TOPICS

There are five research groups at the School of Technology Management, namely Digital Business Strategy, Risk Management, Behavioural Decision Making, Energy Commodity Trading & Financial Engineering, and Financial Mathematics. The Digital Business Strategy group provides research leadership for the emerging digital economy and concentrates on such diverse research areas as IT-enabled organizational innovation, IT economics, business process mining, and social technologies.

Some of the research topics are as follows:

- Core research area Dr. Wooje Cho is information technology strategy, which has two dimensions: (1) strategic management of IT for general firms and (2) strategy for IT firms. The first research dimension includes the topics of IT portfolio management and information security. The second dimension deals with investments in software quality for vendors, software engineering issues, as well as merging and acquisition strategies for IT firms.

- Dr. Changyoung Lee focuses in his research on future-oriented technology analysis, systematic technology intelligence, robust technology planning, intellectual property management, and service science.

- Dr. Minseok Song works on the topics of BPM and process mining. Areas of his particular research interest include process mining in healthcare industry and analysis of manufacturing processes. Dr. Song is currently involved in several research projects with industry partners aimed at development of process mining techniques adjusted to industry characteristics.



## CURRENT RESEARCH PROJECTS

Process Analysis for Manufacturing Execution Systems funded by Samsung Electro-Mechanics. *Project duration: 2013.*

Outpatient Process Analysis and Improvement funded by Borame Hospital. *Project duration: 2013.*

Development of Software for the Automated Business Process Analysis of the Enterprise Big Data for Business Tasks and Collaboration Management funded by the Ministry of Knowledge Economy. *Project duration: 2013–2014.*

Process Mining in Case Handling Processes funded by the National Science Foundation of Korea. *Project duration: 2011–2016.*

Process Mining in B2C Service Industry funded by the Ministry of Knowledge Economy. *Project duration: 2011–2016.*

## AWARDS

**Best Paper Award:** R. Subramanyam, W. Cho, and M.S. Krishnan, "External Sourcing of IT Service: Strategic Driver of Service Quality," 2013 KSMS Spring International Conference, Seoul, Korea.

**2<sup>nd</sup> Best Paper Award:** E. Kim, S. Kim, M. Cho, M. Song, S. Yoo, "Simulation of Optimal Number of Outpatient Payment KIOSK Estimation Using Process Mining", 2013 Korean Society of Medical Informatics Spring Conference, Seoul, Korea.



## PUBLICATIONS

W. Cho, M. J. Shaw, and H. D. Kwon, "The Effect Of Synergy Enhancement On Information Technology Portfolio Selection", Information Technology and Management, Vol.14, No.2, pp.25–142, 2013.

W. Cho and M. J. Shaw, "Portfolio Selection Model for Enhancing Information Technology Synergy", forthcoming at IEEE Transactions on Engineering Management.

W. Cho, R. Subramanyam, and M. Xia (equal authorships) "Vendors' Incentives to Invest in Software Quality in Enterprise Systems", forthcoming at Decision Support Systems.

M. Song, H. Yang, S.H. Siadat, and M. Pechenizkiy, "A comparative study of dimensionality reduction techniques to enhance trace clustering performances", Expert Systems with Applications, Vol.40, No.9, pp.3722–3737, 2013.

A. Kumar, R.M. Dijkman, and M. Song, "Optimal resource assignment in workflows for maximizing cooperation", 11th International Conference on Business Process Management, Beijing, China, August 26-30, 2013.

C. Lee, C. Son, B. Yoon, and Y. Park, "An instrument for discovering new mobile service opportunities", International Journal of Mobile Communications, Vol.11, No.4, pp.374–392, 2013.

C. Lee, B. Song, and Y. Park, "How to assess patent infringement risks: A semantic patent claim analysis using dependency relationships, Technology Analysis and Strategic Management, Vol.25, No.1, pp.23–38, 2013.

B. Song, C. Lee, and Y. Park, "Assessing the risks of service failures based on ripple effects: A Bayesian network approach", International Journal of Production Economics, Vol.141, No.2, pp.493–504, 2013.



## CONTACT DETAILS

**DR. MINSEOK SONG**  
School of Technology Management

Ulsan National Institute of Science and Technology  
UNIST-gil 50, Ulsan 689-798, Republic of Korea  
P+82 52 217 3116  
<http://management.unist.ac.kr>  
[msong@unist.ac.kr](mailto:msong@unist.ac.kr)

## KEY FACTS

### INSTITUTION

- Founded in 2009
- 5 000 students
- School of Technology Management with 420 students and 30 faculty members

### RESEARCH TOPICS

- Digital Business Strategy (IT-enabled organizational innovation, IT governance and security, IT economics, economics in the digital age, business process mining/data mining, e-Commerce/e-Education, and social media)
- Behavioural Decision Making
- Risk Management
- Energy Commodity Trading and Financial Engineering
- Financial Mathematics



# UNIVERSITY OF LIECHTENSTEIN – INSTITUTE OF INFORMATION SYSTEMS – HILTI CHAIR OF BUSINESS PROCESS MANAGEMENT



## ABOUT THE INSTITUTION

The Institute of Information Systems at the University of Liechtenstein was founded in the early 1990's and has been continuously growing since then. The institute offers a Master's program in IT & Business Process Management and a major in Information Management & IT within the Bachelor's program in Business Administration.

The institute is a co-founder of the Hilti Fellowship Program that provides highly motivated and committed Master's students with the opportunity to do an internship at the Hilti Corporation in Liechtenstein while, at the same time, studying in the Master's program in IT and BPM at the University of Liechtenstein. Currently welcoming applications for the 14<sup>th</sup> call of the Hilti Fellowship, the program is a vital element of student exchange within the ERCIS network. In the last year, students from Estonia, Finland, Germany, and Russia participated in the program (more information available at [www.uni.li/hilti-fellowship](http://www.uni.li/hilti-fellowship)).



Hilti Fellowship

The institute represents the Association for Information Systems (AIS) in Liechtenstein through the Liechtenstein Chapter of the AIS (LCAIS). Iris Junglas (Florida State University, Tallahassee, USA), Marcello La Rosa and Jan Recker (both from the Queensland University of Technology, Brisbane, Australia), and Günter Schmidt (Saarland University, Saarbrücken, Germany) have been awarded LCAIS research fellowships and visit the institute on a regular basis.

## RESEARCH TOPICS

Research at the institute specializes in the multidisciplinary field of Business Process Management (BPM) and a number of Information Systems (IS) topics. Members of the institute have published in prestigious IS journals, including MIS Quarterly, Journal of the AIS, Journal of MIS, and Journal of Information Technology.

Our main research areas include, but are not limited to:

- Creativity and innovation in IS
- Culture and people in BPM
- Green IS and Green BPM:
- Information and content management
- Big Data Analytics
- IT and BPM value
- Emergent research methods in IS and BPM

## AWARDS

### 2013 Liechtenstein Young Researcher Award

Theresa Schmiedel has been awarded for the best PhD Thesis of the academic year at the University of Liechtenstein, with her thesis on the Role of Culture in Business Process Management.

Christian Sonnenberg has been awarded for the most outstanding research project of the academic year, with his work on the Process Accounting Model (PAM).

### Student Best Paper Award

Sanja Tumbas and Theresa Schmiedel have received the best student paper award at the International Conference on Wirtschaftsinformatik 2013. An international jury has selected the paper on BPM culture out of more than 40 submissions.

### Invitation to Innojam

Students in the master's degree program in IT and BPM were awarded to participate at the Innojam at SAP TechEd, a premier technical education IT conference held in Las Vegas. Adela Calin, student at the University of Liechtenstein, was part of Innojam winning team and presented their project in front of more than 10000 visitors.

### Young Research Fellow at the Nobel Laureate Meeting 2014

Oliver Müller and Stefan Debortoli have been elected Young Research Fellows at the 2014 Nobel Laureate Meeting in Lindau.

## EVENTS

### Co-Chairs DESRIST 2013

Jan vom Brocke co-chaired the International Conference on Design Science Research in Information Systems and Technology (DESRIST) together with Matti Rossi from Aalto University in Finland. Stefan Seidel co-chaired the Products & Prototypes Track. DESRIST 2013 received an all-time high number of submissions from all over the world.

## PUBLICATIONS

### Journal Publications:

*Schmiedel, T., vom Brocke, J., & Recker, J. (2014, forthcoming).* Development and Validation of an Instrument to Measure Organizational Cultures' Support of Business Process Management. *Information & Management*, 51.

*Seidel, S., Recker, J., & vom Brocke, J. (2013).* Sensemaking and Sustainable Practicing: Functional Affordances of Information Systems in Green Transformations. *Management Information Systems Quarterly*, 37(4), 1275–1299.

*vom Brocke, J., Watson, R., Dwyer, C., Elliot, S., & Melville, N. (2013, forthcoming).* Green Information Systems: Directives for the IS Discipline. *Communications of the Association for Information Systems*.

*Seidel, S., & Urquhart, C. (2013).* On Emergence and Forcing in Information Systems Grounded Theory Studies: The Case of Strauss and Corbin. *Journal of Information Technology*, 28(3), 237–260.

*vom Brocke, J., Riedl, R., & Léger, P.-M. (2013).* Application Strategies for Neuroscience in Information Systems Design Science Research. *Journal of Computer Information Systems*, 53(3), 1–13.

*vom Brocke, J., Liang, T.-P. (2014, forthcoming).* Guidelines for Neuroscience Studies in Information Systems Research. *Journal of Management Information Systems*.

*vom Brocke, J., & Lippe, S. (2013).* Identifying and Managing Creative Tasks in Collaborative IS Research Projects. *Project Management Journal*, 44(6).

*vom Brocke, J., Debortoli, S., Müller, O., & Reuter, N. (2014, forthcoming).* How In-Memory Technology Can Create Business Value: Insights from the Hilti Case. *Communications of the Association for Information Systems*.

*Sonnenberg, C., & vom Brocke, J. (2014, forthcoming).* The Missing Link Between BPM and Accounting – Using Data for Accounting in Process-oriented Organizations. *Business Process Management Journal*.

*vom Brocke, J., Schmiedel, T., Recker, J., Trkman, P., Mertens, W., & Viaene, S. (2014, forthcoming).* Ten Principles of Good Business Process Management. *Business Process Management Journal*.

*vom Brocke, J., Braccini, A., Sonnenberg, C., & Spagnoletti, P. (2014, forthcoming).* Living IT Infrastructures – An Ontology-based Approach to Aligning IT Infrastructure Capacity and Business Needs. *International Journal of Accounting Information Systems*, 15.

## Books

*vom Brocke, J., Simons, A. (Eds.). (2014).* Enterprise Content Management in Information Systems Research : Foundations, Methods and Cases. Berlin et al.: Springer.

*vom Brocke, J., Hekkala, R., Ram, S., Rossi, M. (Eds.). (2013).* Design Science at the Intersection of Physical and Virtual Design. *Lecture Notes in Computer Science (LNCS7939)*. Berlin et al.: Springer

*vom Brocke, J., Rosemann, M. (Eds.). (2013).* Manual de Business Process Management (BPM) (in Portuguese). Bookman: McGraw-Hill.

## Book chapters:

*vom Brocke, J., Seidel, S., & Recker, J. (2013).* Green IS. In K. Kurbel, J. Becker, N. Gronau, E. Sinz & L.Suhl (Eds.), *Enzyklopädie der Wirtschaftsinformatik (7 ed.)*. München: Oldenbourg Wissenschaftsverlag.

*Schmiedel, T., vom Brocke, J., Uhl, A., & Zeitz, S. (2013).* A Global HR Transformation: How a Leading Company Leveraged the Innovative Power of IT. In A. Uhl & L. A. Gollenia (Eds.), *Business Transformation Essentials. Case Studies and Articles* (pp. 159–172). Gower.

*Müller, O., vom Brocke, J., von Alm, T., & Uhl, A. (2013).* The Evolution of SAP Services. In A. Uhl & L. A. Gollenia (Eds.), *Business Transformation Essentials. Case Studies and Articles* (pp. 189–200). Gower.

## DISSERTATIONS

In April 2013, Christian Sonnenberg received the degree of a Doctor of Philosophy at our university for his cumulative PhD thesis on “Bridging the gap between business process management and accounting: Design and evaluation of a process accounting model.”



## CONTACT DETAILS

**PROF. DR. JAN VOM BROCKE**  
Hilti Chair of Business Process Management

University of Liechtenstein  
Fürst-Franz-Josef-Strasse 21  
9490 Vaduz  
Principality of Liechtenstein  
P +423 265 1300  
[www.uni.li/is](http://www.uni.li/is)  
[iwi@uni.li](mailto:iwi@uni.li)

## KEY FACTS

### INSTITUTION

- Founded in 1991
- Researchers: 15

### RESEARCH TOPICS

- Creativity and innovation in IS
- Culture and people in BPM
- Green IS and Green BPM
- Information and content management
- IT and BPM value
- Emergent research methods in IS and BPM



# VIENNA UNIVERSITY OF ECONOMICS AND BUSINESS – DEPARTMENT OF INFORMATION SYSTEMS AND OPERATIONS



## ABOUT THE INSTITUTION

The Department of Information Systems and Operations, Vienna University of Economics and Business (WU Vienna), was founded in the course of WU's organizational restructuring in 2005. Since then, it has consolidated the know-how and reputation of five highly renowned institutes and 16 professors with distinguished focuses in research and teaching, providing a broad representation of IS research topics. Our Bachelor's Program in Information Systems is recognized as Austria's leading degree programs in this field (according to Format Uni-Ranking, 2009).

The recently-established Master's Program in Information Systems (launched in winter semester 2012/13) ambitiously attempts to follow in these successful steps.

## NEW TEAM MEMBER

Axel Polleres joined the Institute for Information Business in September 2013 as a full professor in the area of Data and Knowledge Engineering. He obtained his Ph.D. and habilitation from Vienna University of Technology and worked at University of Innsbruck, Austria, Universidad Rey Juan Carlos, Madrid, Spain, the Digital Enterprise research Institute (DER) at the National University of Ireland, Galway, and for Siemens AG's Corporate Technology Research division before joining WU Vienna. His research focuses on querying and reasoning about Ontologies, Rules Languages, Logic Programming, Semantic Web technologies, Web Services, Knowledge



Management, Linked Open Data, Configuration Technologies and their applications. He has worked in several European and national research projects in these areas. Axel has published more than 100 articles in journals, books, and conference and workshop contributions and co-organized several international conferences and workshops in the areas of Logic Programming, Semantic Web, Data Management, Web Services and related topics and acts as editorial board member for SWJ and IJSWIS. Moreover, he actively contributed to international standardization efforts within the World Wide Web Consortium (W3C) where he co-chaired the W3C SPARQL working group.



New team member  
Axel Polleres

## RESEARCH PROJECTS

The Department of Information Systems and Operations is currently involved in numerous research projects. To name a few: (1) Axel Polleres is involved with the research project which has duration of three years "SPARQL Evaluation and Extensions". This project aims towards laying the foundation for an efficient evaluation of queries in the Semantic Web query language SPARQL. Prof. Dr. Kurt Hornik and Heinz Lang are involved with the research project "A Decarbonisation Platform for Citizen Empowerment and Translating Collective Awareness into Behavioral Change". They are developing techniques to raise awareness among citizens about the long-term impact of their actions on climate change. On March 2013 the kickoff workshop for the Riskbit project has taken place, where seven managers of Erste Bank Group together with Prof. Dr. Edward Bernroider, MMag. Stefan Bauer and Dr. Katharina Chudzikowski defined the project goals and milestones. The main aim of the two staged research project is to improve bank employee risk behavior concerning IT operational risks in the Erste Bank Group with a focus on Central and Eastern Europe (CEE).

## EVENTS

The official opening of the spectacular new WU Campus took place on the 4<sup>th</sup> of October 2013. Thousands of guests, including President Heinz Fischer, have gathered to pay tribute to the new campus. The housewarming party of the Department of Information Systems and Operations took place on the 15<sup>th</sup> of November, where our guests had the opportunity to get to know our new premises and get informed about the current activities of our department.



## NEW BOOK



"Fundamentals of Business Process Management" written by Marlon Dumas, Marcello La Rosa, Jan Mendling and Hajo. A. Reijers is a new book designed for educators and students that provides an excellent introduction to the subject of Business Process Management. It encompasses the entire BPM lifecycle, from process identification to process monitoring, covering along the way process modeling, analysis, redesign and automation.

## PUBLICATIONS

H. Leopold, J. Mendling, H.A. Reijers, M. La Rosa (accepted for publication): Techniques for Generating Model Names. Information Systems.

H. Leopold, R. Eid-Sabbagh, J. Mendling, L. Guerreiro Azevedo, . Araujo Baiao (accepted for publication): Detection of Naming Convention Violations in Process Models for Different Languages. Decision Support Systems.

J. Recker, C. Hahn, J. Mendling (2013): How Collaborative Technology Supports Cognitive Processes in Collaborative Process Modeling: A Capabilities-Gains-Outcome Model. Information Systems, 38 (8), 1031–1045.

K. Figl, J. Recker, J. Mendling (2013): A Study on the Effects of Routing Symbol Design on Process Model Comprehension. Decision Support Systems, 54 (2), 1104–1118.

K. Figl, J. Mendling, M. Strembeck (2013): The Influence of Notational Deficiencies on Process Model Comprehension. Journal of the Association for Information Systems, 14 (6).

N. Loehndorf, S. Minner (2013): Simulation optimization for the stochastic economic lot scheduling problem. IIE Transactions, 45 (7), 796–810.

N. Loehndorf, D. Wozabal, S. Minner (2013): Optimizing Trading Decisions for Hydro Storage Systems Using Approximate Dual Dynamic Programming. Operations Research, 61 (4), 810–823.

E. Bernroider, J-R. Córdoba, A. Pilkington (2013): Research in Information Systems: A Study of Diversity and Inter-Disciplinary Discourse in the AIS Basket Journals between 1995 and 2011. Journal of Information Technology, 28, 74–89.

E. Bernroider, S. Koch, V. Stix (2013): A Comprehensive Framework Approach using Content, Context, Process Views to Combine Methods from Operations Research for IT Assessments. Information Systems Management, 30 (1), 75–88.



## CONTACT DETAILS

### MONIKA MALINOVA

Teaching and research Associate,  
Department for IS and Operations  
Vienna University of Economics  
and Business  
Building D2, Welthandelsplatz 1  
1020 Vienna, Austria  
P +43 1 31336 5206  
www.wu.ac.at/ipm  
monika.malinova@wu.ac.at

## KEY FACTS

### INSTITUTION

- Founded in 2005
- More than 60 researchers

### RESEARCH TOPICS

- Business Process Management
- Process Mining
- Supply Chain Operations Planning
- Social Aspects of IS
- Business Programming
- Knowledge Management
- Semantic Web Technologies
- Operations Research
- Decision Support Systems
- Computer Integrated Manufacturing
- Online Algorithms and Decision Theory
- New Product Development
- Data Modeling and eLearning
- Relation Theory
- eGovernment and eVoting
- eMarketing and Software Agents
- Secure Business Systems





## ABOUT THE INSTITUTION

Waikato Management School is accredited by AACSB International, EQUIS – the European Quality Improvement System, and AMBA – the UK-based Association of MBAs. AACSB is the US-based Association to Advance Collegiate Schools of Business and is the world's oldest-established quality assurance body in management education.

These accreditations are reviewed every few years by a team of academics from business schools around the world to ensure Waikato Management School staff continue to offer high quality and relevant teaching and that our top research rankings, programming and planning are maintained to international standard. The Waikato Management School is the top-ranked business school in New Zealand based on PBRF research productivity assessments.

As one of eight departments in the school, the Department of Management Systems is home to the disciplines of e-business, e-commerce, supply chain management and, logistics. To a lesser degree, project management, decision making and knowledge management are also taught.

## RESEARCH TOPICS

Our research reflects the multidisciplinary nature of the department. Recent relevant research projects focus on:

- IT project management
- Data marketplaces
- Data curation
- Website alignment
- Electronic government
- The IS research discipline
- Systems intelligence
- Knowledge transfer

## CURRENT RESEARCH

In association with Prof Gottfried Vossen from Muenster, a project is underway looking into a range of related issues associated with data curation, presentation of curated data on mobile devices, and data storage and presentation without internet access. One of the key outputs of this work to date has been the **Web In Your Pocket (WiPo)** concept which addresses all of the issues above. Several outputs have resulted including work around the issues of information overload from web sources as well as the exploratory application of the WiPo concept across a number of potential use cases such as within the tourism, emergency management and healthcare sectors.

Another international collaborative project (involving Waikato, QUT & Muenster) that was funded as part of the NSS project, has contrasted the policy maker views around e-local government in each of Germany, Australia and New Zealand. A number of research publications are underway. Empirical research is also underway looking at the competencies of IT project managers. This project, carried out with the University of Washington is uncovering a number of interesting attributes of successful IT project managers.

A number of other relevant research projects are on-going in the areas of systems intelligence, knowledge sharing, supply chain integration, and emergency management.

## PUBLICATIONS

Here are some of the more significant articles published recently:

*Ab Wahid, Roslina; Corner, James (2011)*, Critical success factors and improvements in ISO 9000 maintenance, *Business and Management Quarterly Review*, 2, 2, 1–13.

*Basnet, Chuda; Wisner, Joel (2012)*, Nurturing internal supply chain integration, *Operations and Supply Chain Management*, 5, 1, 27–41.

*Cataldo, Alejandro; McQueen, Robert; Sepulveda, Marcos (2012)*, Big IT for small companies, *Industrial Engineer*, 43, 5, 48–53.

*Cataldo, Alejandro; Sepulveda, Marcos; McQueen, Robert (2012)*, Exploring the IT usage in SMEs from New Zealand, Columbia and Chile using action-research methodology, *Journal of Innovation Management in Small and Medium Enterprises*, 2012, 1–8.

*Chen, Jihong; McQueen, Robert; Sun, Peter (2013)*, Knowledge transfer and knowledge building at offshored technical support centers, *Journal of International Management*, -online, 1–15.

*Childerhouse, Paul; Deakins, Eric; Bohme, Tillman; Towill, Denis; Disney, Stephen; Banomyong, Ruth (2011)*, Supply chain integration: An international comparison of maturity, *Asia Pacific Journal of Marketing and Logistics*, 23, 4, 531–552.

*Childerhouse, Paul; Towill, D (2011)*, Effective supply chain research via the quick scan audit methodology, *Supply Chain Management: An International Journal*, 16 (1) : 5–10.

*Hung, Wei-Hsi; McQueen, Robert; Ku, Cheng-Yuan; Chang, Li-Min (2012)*, Aligning websites with enterprise success: An evaluative approach, *Journal of Computer Information Systems*, 52, 4, 49–58.

*Hung, Wei-Hsi; Tsai, Chia-An; Hung, Shin-Yuan; McQueen, Robert; Jou, Jau-Jeng (2011)*, Evaluating web site support capabilities in sell-side B2B transaction processes: A longitudinal study of two industries in New Zealand and Taiwan, *Journal of Global Information Management*, 19, 1, 51–79.

*Jones, Rachel; Corner, James (2012)*, Seeing the forest and the trees: A complex adaptive systems lens for mentoring, *Human Relations*, 65, 3, 391–411.

*Jones, Rachel; Corner, James (2012)*, Stages and dimensions of systems intelligence, *Systems Research and Behavioral Science*, 29, 30–45.

*McQueen, Robert; Daud, Nordiana (2013)*, Relationships between micro-enterprises and web developers: Roles, misconceptions and communication, *International Journal of E-Entrepreneurship and Innovation*, 4, 1, 28–42.

*Rusly, Fariza; Corner, James; Sun, Peter (2012)*, Positioning change readiness in knowledge management research, *Journal of Knowledge Management*, 16, 2, 329–355.

## DISSERTATIONS

*Wilkinson, Gustav*: Activity-based measurement extending attribute-based measurement of learning organisations, 2013

*Ab Wahid, Roslina*: The maintenance of ISO 9000 in Malaysian service organisations, 2011

*Williams, David*: An investigation into tacit knowledge management at the supervisory level, 2011



## CONTACT DETAILS

**DR. STUART DILLON**  
Waikato Management School

University of Waikato  
Department of Management Systems  
Private Bag 3105, Hamilton,  
3240 New Zealand  
P +64 7838 4563  
[mngt.waikato.ac.nz/msys](http://mngt.waikato.ac.nz/msys)  
[stuart@waikato.ac.nz](mailto:stuart@waikato.ac.nz)

## KEY FACTS

### INSTITUTION

- founded in 1964
- The Department of Management Systems is one of eight departments in the Faculty of Management
- 7 full time researchers

### RESEARCH TOPICS

- IT project management
- Data marketplaces
- Data curation
- Website alignment
- Electronic government
- The IS research discipline
- Systems intelligence
- Knowledge transfer





## › CLOUD COMPUTING

Since its initiation in spring 2011, the ERCIS Cloud Computing Competence Center (C4) has seen a variety of activities, mostly in the form of talks by cloud experts and invited talks, concentrated on the topic of cloud services at all levels (infrastructure, platform, and service) with a particular focus on small and medium-sized enterprises (SMEs). C4 sees its major mission in helping regional SMEs to overcome the doubts and hesitations they might have about “moving into the cloud”. During 2013 it became obvious that cloud computing is a core enabler for any application that handles big data. In addition to organizing events, C4 publishes condensed summaries of hot topics in cloud computing in its C4 Management Briefs series. To find out more, please visit <http://ercis.org/research/competence-center-cloud-computing> or contact [c4@ercis.uni-muenster.de](mailto:c4@ercis.uni-muenster.de).



## CONTACT DETAILS

### COMPETENCE CENTER CLOUD COMPUTING

University of Münster  
ERCIS – Competence Center  
Cloud Computing  
Leonardo-Campus 3  
48149 Münster, Germany

### PROF. DR. GOTTFRIED VOSSEN

P +49 251 83-38151  
[c4@ercis.uni-muenster.de](mailto:c4@ercis.uni-muenster.de)

## › ERP

Within the ERCIS network, the Center provides theoretical and applied research in the area of Enterprise Resource Planning, supports ERP related customer oriented consulting and case studies development for student teaching in Production Planning and Control, other related areas.

Competence Center Mission: Understanding the design and management of business software and integrated aspects of enterprise software and software-related services.

Some of the key activities of the Competence Center in 2013 are:

- the research on new approaches in developing engineering cloud concepts for design and manufacturing
- the analysis of SAP solutions for eHealth in cooperation with T-Systems
- the analysis of ERP solutions for Higher Education and Research as part of EDU-PASS seminar in cooperation with T-Systems and SAP
- cooperation started with SKOLKOVO School of Management, Russia, promoting of ERCIS approaches of information systems solutions for Russian Universities
- ERCIS and SAP joint seminar at SAP University Alliances Congress in Munich
- participation in special research track in Very Large Business Applications (VLBA) at SAP University Alliances Congress EMEA, SAP University Alliances Congress Americas
- participation in advisory board of International Institute of Performance Management (IPERF)
- participation in SAP Business Forum in Moscow
- organization of keynote talks of SAP Research scientists: Prof. Dr. Jan Eloff, Research Director at SAP Research / Meraka UTD and Prof. Uwe Kubach, Vice President M2M/IoT Engineering at SAP AG

--the discussion is under way to use ERCIS Competence Center ERP expertise to develop a methodology to empower SMB in emerging markets through integrated business-academia knowledge transfer in cooperation with SAP Global SMB, SAP Academic Competence Center Valais (Switzerland) and Higher School of Economics.



From left to right: Yury Kupriyanov, SAP, Prof. Dr. Jörg Becker, ERCIS, Dr. Dr. Victor Taratoukhine, ERCIS, at SKOLKOVO School of Management, Russia

### Academic partners

University of Wuerzburg, Cranfield University, University of Cologne, Higher School of Economics, ERCIS Lab Russia, SKOLKOVO School of Business, TU Wien, TU Munich

### Industry partners

SAP, T-Systems AG, T-Systems CIS, SAP Lab network, SAP Research South Africa



## CONTACT DETAILS

### COMPETENCE CENTER ERP

University of Münster  
ERCIS – Competence Center ERP  
Leonardo-Campus 3  
48149 Münster, Germany

### DR. DR. VICTOR TARATOUKHINE

P +49 251 83-38074  
[victor.taratoukhine@ercis.uni-muenster.de](mailto:victor.taratoukhine@ercis.uni-muenster.de)



## CONNECTED ORGANIZATION

The Competence Center Connected Organization (3CO) was founded in spring 2013. Its goal is to examine the influence of upcoming IT-technologies and trends on organizations. The 3CO currently focuses on two major developments which increasingly affect organizations: **social media** and **mobile services**.

Social media have led to wide-ranging changes in public communication as well as between enterprises and customers. Whereas companies were equipped with the "speaker role" in **public communication**, they now obtain the possibility of publishing opinions and discussing them. As a result, organizations might exploit new potentials but are also faced with challenges, e.g. in the fields of brand communication, customer relationship management, and innovation management. Research as well as practice seek to better understand this public communication by investigating "big data" in social media. The 3CO built up a profound knowledge in the field of social media analytics. Furthermore, tools were developed to support data tracking and analysis (e.g. network analysis, sentiment analysis, and text mining). In 2013 we participated in a joint project with **Vodafone Institute for Society and Communication** and the **Konrad-Adenauer Foundation**. Based on the collection and analysis of social media data we investigated how people communicate on certain topics such as PRISM, Snowden or the German Federal Election.



Student project "Porsche AG"

However, social media are not only used publicly. The adoption and use of internal social media applications in corporate context, widely termed as "**Enterprise 2.0**", has recently received a lot of research interest. Web 2.0 technologies and associated social media applications such as social network sites (SNSs), microblogging, weblogs, content communities, and wikis have been increasingly making their way into organizational environments to improve communication and knowledge management. Two areas the 3CO concentrates on are the change management process as well as the measurement of business values. In 2013 we established a project with **WL Bank**, Münster. The company employs about 200 people and is a player in the financial industry. The goal of the project was to evaluate the company's social media readiness. Therefore, we conducted and analyzed several interviews with employees in order to develop a comprehensive social media strategy.

Another topic we are working on is the idea of a "Mobile Enterprise" which describes the influence of mobile technologies on companies, their processes and employees as well as the societal influence on the changed working environment. We understand a Mobile Enterprise as a company whose strategy it is to execute (critical) business processes by using mobile devices (additionally or exclusively). In this area we support companies to elaborate a mobile strategy which addresses their individual needs. Moreover, we aim on improving working processes by providing mobile applications (software prototypes).

As another mode of cooperation, members of the 3CO organized several **student projects**. In these scenarios students from University of Münster worked together with companies such as **Microsoft**, **Porsche**, **Zweitag** or **Wingas**. Concepts and software prototypes were developed on topics such as "SocialCRM", "Cloud Services@University", "Mobile Learning", and "Internet Car Configurator".



Student project "Wingas"

Besides the mentioned activities, the 3CO aims on connecting academic and practical experts in our fields of interest. This was emphasized by a 3CO's organized activity, the **Smarter Work Excellence Panel (SWEP)**. The event took place in June 2013 at Steigenberger Airport Hotel Frankfurt. 25 researchers and business representatives, employed at companies such as **Deutsche Post**, **IBM**, **Cisco**, **Deutsche Telekom**, and **Bosch**, actively discussed about the potentials, risks, and business values of social business software for enterprises.

Additionally, representatives of the 3CO presented results of their studies on social media usage at **DNUG (Deutsche Notes User Group) – The Enterprise Collaboration Professionals** conference 2013 in Berlin.

### PUBLICATIONS

*Brockmann, T. (2013).* Virtuelle Kundenintegration mittels mobiler Endgeräte. In Proceedings of the Jahrestagung der Gesellschaft für Informatik 2013, Koblenz, 2296–2308.

*Stieglitz, S., Schallmüller, S., & Meske, C. (2013).* Adoption of Social Media for Internal Usage in a Global Enterprise. In Proceedings of the IEEE 27<sup>th</sup> International Conference on Advanced Information Networking and Applications (AINA), Barcelona, Spain, 1483–1488.

*Brockmann, T., & Stieglitz, S. (2013).* The Role of Mobile Social Media in Enterprises. In Bruck, P. A., & Rao, M. (Eds.), *Global Mobile – Applications and Innovations for the Worldwide Mobile Ecosystem* (1<sup>st</sup> ed., 293–311). Information Today Inc.

*Meske, C., & Stieglitz, S. (2013).* Adoption and Use of Social Media in Small and Medium-sized Enterprises. In Harmsen, F., & Proper, H. (Eds.), *Practice-Driven Research on Enterprise Transformation* (61–75). Lecture Notes in Business Information Processing: Vol. 151. Berlin: Springer.

*Bögel, S., Stieglitz, S., & Meske, C. (2013).* Bringing together BPM and Social Software. In Proceedings of the 19<sup>th</sup> Americas Conference on Information Systems (AMCIS), Chicago, USA.

### STUDIES

*Stieglitz, S., Brockmann, T., & Baumann, L. (2013).* "Whatsapp und Co. – Zahlungsbereitschaft für erweiterte Kommunikationsdienste"

*Stieglitz, S., & Brockmann, T. (2013).* "Status Quo von BYOD – Wollen die Mitarbeiter das wirklich?"

## CONTACT DETAILS

### COMPETENCE CENTER CONNECTED ORGANIZATION

University of Münster  
ERCIS – Competence Center  
Connected Organization  
Leonardo-Campus 11  
48149 Münster, Germany

[www.connected-organization.de](http://www.connected-organization.de)



PROF. DR. STEFAN STIEGLITZ

P +49 251 83-38115  
[stefan.stieglitz@ercis.de](mailto:stefan.stieglitz@ercis.de)



TOBIAS BROCKMANN

P +49 251 83-38122  
[tobias.brockmann@ercis.de](mailto:tobias.brockmann@ercis.de)



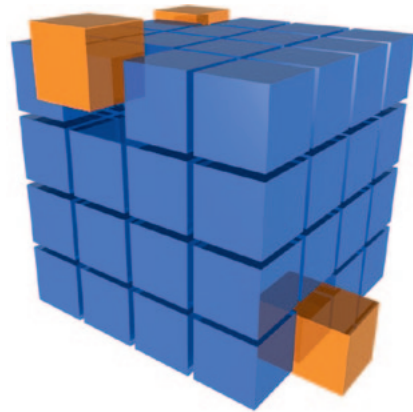

## › CONCEPTUAL MODELING

Conceptual modeling is one of the core research fields in Information Systems engineering. Today, conceptual modeling research focuses on methodologies how to use conceptual models in order to gain benefits for a business. The Competence Center for Conceptual Modelling focuses on automatic support for conceptual model analysis to support model-driven Business Process Reengineering, Business Process Compliance Management, Mergers and Acquisitions, ERP Alignment, Model Driven Software Engineering, and Benchmarking. Through automation, we can partly avoid lengthy manual conceptual model processing steps and hence generate benefit for a company.

Amongst others, we worked on the following research projects:

– **The Generic Model Query Language (GMQL):** A query language for conceptual models, supporting the identification of business process weaknesses, the violation of compliance rules, syntax errors, etc.

– **A visual model query language:** We further developed GMQL and improved the way of specifying a model query. While in GMQL, this is done by nested set operations and the user has to use formal expressions to build a query, the new language allows for simply drawing a query.

– **Efficient analysis of very large models and model collections:** We identified graph-based model characteristics that allow analyzing conceptual models with faster algorithms. In particular, bounded tree-width and planarity of conceptual models help increasing analysis performance.

– **Business Process Compliance Management:** We applied our knowledge on model querying to business process models to be checked for compliance. To prove the utility of model-driven Business Process Compliance Checking, we collaborate with companies from the financial sector.

Our research on Business Process Compliance Management is funded by the German Research Foundation (DFG) from 2012-09 to 2014-09. Due to the frequent use of conceptual models in many domains, the Competence Center for Conceptual Modeling is closely linked to and co-operates with the Competence Centers of E-Government, ERP, and Service Sciences.

### SELECTED PUBLICATIONS

*Becker, J., Beverungen, D., Knackstedt, R., Rauer, H. P., Sigge, D. (2013).* On the Ontological Expressiveness of Conceptual Modeling Grammars for Service Productivity Management. *Information Systems and e-Business Management*, in press.

*Becker, J., Eggert, M., Saat, J., Bruning, D. (2013).* Applicability of Business Process Model Analysis Approaches – A Case Study in Financial Services Consulting. In: *Proceedings der 11. Internationalen Konferenz Wirtschaftsinformatik*. Leipzig, Germany.

*Bräuer, S.; Delfmann, P.; Dietrich, H.; Steinhorst, M. (2013).* Using a Generic Model Query Approach to Allow for Process Model Compliance Checking – An Algorithmic Perspective. In: *Proceedings der 11. Internationalen Konferenz Wirtschaftsinformatik*. Leipzig, Germany.

*Breuker, D. (2014).* Towards Model-Driven Engineering for Big Data Analytics – An Exploratory Analysis of Domain-Specific Languages for Machine Learning. In *Proceedings of the 47<sup>th</sup> Hawaii International Conference on System Sciences (HICSS-47)*, Waikoloa, Big Island, USA.

*Breuker, D., Matzner, M. (2013).* Statistical Sequence Analysis for Business Process Mining and Organizational Routines. In *Proceedings of the European Conference on Information Systems (ECIS)*, Utrecht, Netherlands.

*Clever, N., Holler, J., Shitkova, M., & Becker, J. (2013).* Towards Auto-Suggested Process Modeling – Prototypical Development of an Auto-Suggest Component for Process Modeling Tools. In *Proceedings of the 5th International Workshop on Enterprise Modelling and Information Systems Architectures (EMISA 2013)*, St. Gallen, Switzerland.

*Dietrich, H.-A., Breuker, D., Steinhorst, M., Delfmann, P., Becker, J.,* Developing Graphical Model Editors for Meta-Modelling Tools – Requirements, Conceptualisation, and Implementation. *Enterprise Modelling and Information Systems Architectures 8 (2013) 2*, in press.

*Knackstedt, R., Heddier, M., & Becker, J. (2013).* Conceptual Modeling in Law: An Interdisciplinary Research Agenda. *Communications of the AIS (CAIS)*, 33.

*Pflanzl, N., Breuker, D., Dietrich, H.-A., Steinhorst, M., Shitkova, M., Becker, J., Delfmann, P.* A Framework for Fast Graph-based Pattern Matching in Conceptual Models. In *Proceedings of the IEEE Conference on Business Informatics*. Vienna, Austria 2013.

*Steinhorst, M. (2013).* iARIS – Supporting Enterprise Transformation Using An Iterative ISD Method. In *Proceedings of the 21st European Conference on Information Systems (ECIS)*, Utrecht, Netherlands.

*Steinhorst, M., Delfmann, P., Becker, J. (2013).* vGMQL – Extending a generic model query language to include a visual query editor. *Proceedings der 6<sup>th</sup> IFIP WG 8.1 Working Conference on The Practice of Enterprise Modeling (PoEM)*.



## CONTACT DETAILS

### COMPETENCE CENTER CONCEPTUAL MODELING

University of Münster  
ERCIS – Competence Center  
Conceptual Modeling  
Leonardo-Campus 3  
48149 Münster, Germany

### PD DR. PATRICK DELFMANN

P +49 251 83-38083  
patrick.delfmann@ercis.uni-  
muenster.de



## Project on Federal Information Management

Many public administrations actually maintain their information on administrative procedures on their own. This leads to a heterogeneous information landscape. It is, however, crucial for maintaining a reliable public service that same content is always described in the same way. Here, the FIM project comes into play. Its goal is to build up an information management that supports information exchange across all federal levels between internal processes and between public administrations and citizens. Members of the competence center together with colleagues from Munich and Berlin developed an overall framework for the integration of different information (i.e. the service descriptions, process descriptions and forms) and a procedure model to create and maintain all this integrated information. Furthermore, a conceptual model for the integrated and harmonized development of reference forms was developed and is now ready for implementation.



## Project on integrated service points for the German eID

Like many European countries, Germany has introduced an electronic ID card. Based on the results of a survey within the University of Münster, we set up a project together with citeq (IT provider of the City of Münster), ZIV (IT provider of the University) as well as the IT provider of the central units of the University. The goal of this project is to first define a service catalogue from a student's point of view which consists of services of the University as well as of the city of Münster. Based on this catalogue, an application will be developed which will enable the students of the university to use the services of this

combined service catalogue within a single app with a single authentication process. Furthermore, terminals in central university buildings like the big lecture halls shall foster the students' use and acceptance of this new concept and shall facilitate the use of the German eID for a highly secured way of eGovernment service recovery. We expect to present first results by the end of the first quarter of 2014 and actually plan to be present with our concept at CeBIT 2014 in Hannover in the first week of March 2014.



## Studies of Government Use of Social Media

Social media have become an integral part of the communication strategy in many businesses. Although they offer potentials for governments, too, the public sector has not yet started to use social media in a strategic way. In two student projects qualitative studies on the reasons of offering or non-offering of public administrations as well as the reasons of citizens to use or not use information offerings of public administrations on Facebook where conducted.

First finding show that Facebook pages of public administrations are mainly driven by single employees of the organizations instead of a strategic concept and organizational setting in the background. Subsequently a strategic use of social media channels as communication channel is not yet in the focus.

Coming from a user's perspective, the main reasons for liking and following a public administration's page are more private ones. The users want to be informed about things going on in the city. The idea is not to find or to perform complete e-Government Services via this channel.

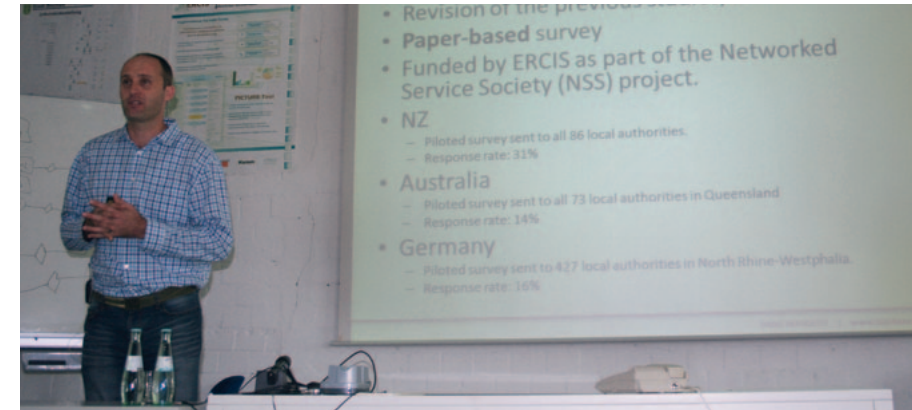

## Survey of E-Government Readiness in New Zealand, Australia, and Germany

In 2012, together with the ERCIS partner universities in Waikato, New Zealand, and Brisbane, Australia, we sent a questionnaire to municipal governments asking them about their e-government status, their communication strategy as well as further mobile developments. To discover the extent that structural transformation has actually been achieved by local government organizations we set up this cross-national comparison of local e-government effectiveness from the perspective of the internal stakeholders. Rather than being transformative, only incremental improvements to internal procedures and service quality were reported. It appears that e-government is viewed by the policymakers charged with developing it as something that supplements, rather than displaces, traditional government services.

In May 2013, Stuart Dillon from University of Waikato presented the results achieved during the ERCIS Lunchtime seminar in Münster.

## PUBLICATIONS

*Hofmann, S., Beverungen, D., Räckers, M., & Becker, J. (2013).* What Makes Local Governments' Online Communications Successful? Insights from a Multi-Method Analysis of Facebook. *Government Information Quarterly*, in press. (Accepted)

*Hofmann, S., Räckers, M., Beverungen, D., & Becker, J. (2013).* Old Blunders in New Media? How Local Governments Communicate with Citizens in Online Social Networks. In *Proceedings of the 46<sup>th</sup> Hawaii International Conference on System Sciences (HICSS-46)*, Maui, Hawaii.

*Plattfaut, R., Hofmann, S., Kohlborn, T., Beverungen, D., Räckers, M., Niehaves, B., & Becker, J. (2013).* Verwaltungsdienstleistungen für Personen mit eingeschränkter Mobilität: Von mobilen Bürgerdiensten zu E-Government?. *eGovernment Review*, 11, 14–15.

*Plattfaut, R., Kohlborn, T., Hofmann, S., Beverungen, D., Niehaves, B., Räckers, M., & Becker, J. (2013).* Unravelling (E-)Government Channel Selection: A Quantitative Analysis of Individual Customer Preferences in Germany and Australia. In *Proceedings of the 46<sup>th</sup> Hawaii International Conference on System Sciences (HICSS-46)*, Maui, Hawaii.

*Räckers, M., Hofmann, S., & Becker, J. (2013).* The Influence of Social Context and Targeted Communication on e-Government Service Adoption. *Lecture Notes in Computer Science*, 8074, 298–309.

## CONTACT DETAILS

### COMPETENCE CENTER E-GOVERNMENT

University of Münster  
ERCIS – Competence Center  
E-Government  
Leonardo-Campus 3  
48149 Münster, Germany



PROF. DR. JÖRG BECKER

P +49 251 83-38100  
joerg.becker@ercis.uni-muenster.de



DR. MICHAEL RÄCKERS

P +49 251 83-38075  
michael.raeckers@ercis.uni-muenster.de





## › ERCIS LAB RUSSIA

ERCIS Lab Moscow at the National Research University Higher School of Economics was formed in 2011 to help Russian academia and industry clients to extend ideas and research directions on Information Systems topics with ERCIS members, to create a direct link between academic research and product development and industry cooperation.

In 2013, ERCIS Lab Moscow was renamed to **ERCIS Lab Russia** as the result of the integration of HSE Moscow and HSE Nizhny Novgorod research directions.

HSE Nizhny Novgorod at ERCSI Lab Russia is represented by the Faculty of Business Informatics and Applied Mathematics. There are several profound research groups established at the Faculty, such as: the research lab "TAPRADESS" for the Theory and Application of Expert Systems, and the international research lab "LATAS" for the Algorithms and Technologies for the Analysis of Network Structures. HSE Nizhny Novgorod contributes the research and overall activity directions of ERCIS Lab Russia.

The overall mission of ERCIS Lab Russia is the following:

- To define connection points between academia and industry in Russia in the situation of changing economic environment and emerging markets specifically in the area of Information Systems, Information Communication Technologies (ICT) and Business Software Technologies.
- To establish the constant interchange of ideas and experiences with Russian companies and public sector on the best research, educational methods and approaches, and the deployment of the latest research findings in the areas of Business Informatics and Management Information Systems.
- To create a framework for the research and academic skills of the 21st century in the areas of Business Informatics and Management Information Systems in order to support talented future academic leaders.

In 2013, ERCIS Lab Russia hosted visiting fellows from Bauman Moscow State Technical University, Southern Federal University, both PhD and MSc students. ERCIS Lab Russia works very closely with the ERCIS HQ in Muenster.

Main research directions in 2013 are:

- Business Transformation and Organizational Change
- Enterprise Architecture and Business Process Management for very large enterprises
- Business Process Management in Design Engineering and Manufacturing, Life-long Product Maintenance
- ERP systems implementation, ERP for Small- and Medium-sized enterprises, Enterprise software and software-related services research
- Business Process Improvement, methodologies and models
- Industry oriented MSc and PhD education

The ERCIS Lab Russia works together with different partners from academia and industry. Currently, the Lab's network includes the following academic partners:

Moscow State Institute of International Relations (MGIMO-University), Moscow State University of Railway Engineering (MIIT), Voronezh State University, The Gubkin Russian State University of Oil and Gas, Bauman Moscow State Technical University, Moscow Power Engineering Institute (Technical University) and Saint-Petersburg Institute for Informatics and Automation of the Russian Academy of Sciences (SPII RAS).

The Lab's industry network spans the following companies: SAP, T-systems, Surgutneftegas, United Metallurgical Company, Joint Stock Company Commercial Bank "Center-invest", Russian Railways, Gazprom and Lukoil.

In 2013, the ERCIS Lab Russia participated in the number of international conferences:

- International IFAC Symposium on Manufacturing Modelling, Management and Control held in Saint Petersburg, Russia, on June 19–21, 2013.



Participants of the Industrial Applications of the Enterprise-Related Methods, Models and Services Research Track at the IFAC Symposium on Manufacturing Modeling, Management and Control.

- In the distinguished research track on Very Large Business Applications (VLBA) at the 18th SAP Academic Conference EMEA hosted by SAP and TU Munich in Munich, Germany, on September 12–15, 2013.

Moreover, ERCIS LAB Russia together with ERCIS HQ in Muenster regularly participates in Media events in order to promote the idea and vision of the international cooperation of academic institutions and industry partners on Information System topics:



The ERCIS Lab Russia together with Prof. Dr. Jörg Becker, Prof. h.c. (NRU HSE Moscow) at the Russian-German video conference "Dialog about Science: Start with the Future", hosted by Deutsche Welle, in Münster, Germany, November 2012.

The goal of ERCIS Lab Russia is to continuously improve its position, deepen the expertise and extend the collaboration network, benefiting from the worldwide reputation of ERCIS and a great knowledge and experience of Russian academia and industry.

## CONTACT DETAILS

### COMPETENCE CENTER ERCIS LAB RUSSIA

University of Münster  
ERCIS – Competence Center  
ERCIS LAB Russia  
Leonardo-Campus 3  
48149 Münster, Germany



PROF. DR. JÖRG BECKER

P +49 251 83-38100  
[joerg.becker@ercis.uni-muenster.de](mailto:joerg.becker@ercis.uni-muenster.de)



DR. DR. VICTOR TARATOUKHINE

P +49 251 83-38074  
[victor.taratoukhine@ercis.uni-muenster.de](mailto:victor.taratoukhine@ercis.uni-muenster.de)



## › SERVICE SCIENCE

The emergence and proliferation of the Service Economy has changed the way in which the creation of value is perceived throughout various industry sectors and societies. Some current manifestations are integrating industrial machinery with customized service offerings (customer solutions, product-service systems), offering aircraft turbines (power by-the-hour) or software applications (as-a-service) without selling physical goods, or providing content on mobile platforms. Theories and artifacts related to service are reflected in the emerging academic discipline of Service Science, Management and Engineering (SSME). Research in SSME is focused on understanding and facilitating the creation of value in service systems, involving interactions of service providers and service customers.

### Mission of the Service Science Competence Center

The mission of the ERCIS Service Science Competence Center is twofold. On the one hand, we strive to understand the nature and impact of service orientation on commercial businesses, on the public sector, and on society in general. On the other hand, we contribute to further shaping the course of the service economy by designing new business solutions and software artifacts. One focal point of our research is facilitating service-orientation in close cooperation with high-tech manufacturing companies. We have also been in frequent contact with banks, retail companies, and facility management service providers.

Our research is equally dedicated to research excellence and to providing results that companies can utilize to further shape their businesses in the service society. We achieve this goal based on a network of excellent researchers in the global ERCIS network.



## SERVICE RESEARCH at the European Research Center for Information Systems

In 2013, we focused on three areas of research.

First, in the **Networked Service Society (NSS)** project, we continued to research on service phenomena in a cooperation of WWU (Münster), QUT (Brisbane), UNIST (Ulsan), and Waikato Management School (Hamilton). We conducted research on utilizing enterprise social networks for managing innovations, in cooperation with a leading retail company in Australia. In addition, we applied process mining techniques to analyze the business operations in a Korean hospital. Research visits to Brisbane and Ulsan were carried out in order to further frame our cooperation for the second funding period on the NSS project which started in January 2013. In turn, Profs. Minseok Song and Wooje Cho (UNIST, Ulsan), Stuart Dillon (Waikato University, Hamilton), and Prof. Alexander Dreiling and Dr. Thomas Kohlborn conducted research visits to Münster.

Second, in the research project **ServDEA**, theories and artifacts for service productivity analysis were designed. In research collaborations with leading industrial companies we performed service productivity analyses in order to theorize on the utility of the Data Envelopment Analysis (DEA). In order to enable companies to perform productivity analyses themselves, the software prototype ServDEA was extended and evaluated. We currently develop a design theory based on the results of this research project.

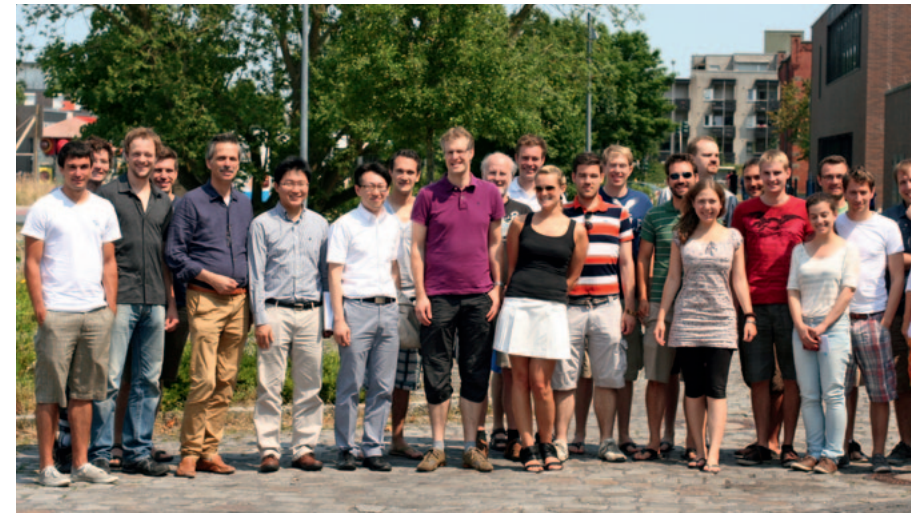

Third, we applied for funding for two new research projects focused on service innovations for electric mobility. The project **EOLIS** focuses on developing second life concepts for used batteries of electric vehicles that cannot be used in cars anymore. Based on a detailed technical and chemical appraisal of the batteries' technical and chemical condition, services can help to select and configure suitable second life scenarios for each of the batteries.

The project **CrowdStrom** develops new solutions for compensating the lack of charging infrastructures for electric vehicles. The idea is to enable the owners of electric vehicles to recharge their cars in each others' homes which would greatly extend the available charging infrastructure. The aim of both projects is to foster the diffusion of electric mobility in Germany.

Based on these projects, we successfully published our work in leading peer-reviewed journals and conferences. In 2013, papers were accepted for publication in the journals *Government Information Quarterly (GIQ)*, *Information Systems and e-Business Management (ISeB)*, *International Journal of Service Operations Management (IJSOM)*, *International Journal of Business Intelligence Research (IJBIR)*, and in the *eGovernment Review*. As regards peer-reviewed articles in conference proceedings, we successfully published two papers at the International Conference on Information Systems (ICIS), as well as articles at the Pacific Asia Conference on Information Systems (PACIS), at the Hawaii International Conference on System Sciences (HICSS), the European Conference on Information Systems (ECIS), and at the Americas Conference on Information Systems (AMCIS). With these papers, researchers of the Service Science Competence Center participated in all major IS conferences in 2013.

In addition, we successfully applied for managing the Track on Service Innovation, Engineering and Management to be held at next year's European Conference on Information Systems (ECIS) in Tel Aviv, Israel.

The track will be hosted by Tuure Tuunanen, Fons Wijnhoven and Daniel Beverungen.

## CONTACT DETAILS

### COMPETENCE CENTER SERVICE SCIENCE

University of Münster  
ERCIS – Competence Center  
Service Science  
Leonardo-Campus 3  
48149 Münster, Germany



DR. DANIEL BEVERUNGEN

P +49 251 83-38092  
[daniel.beverungen@ercis.uni-muenster.de](mailto:daniel.beverungen@ercis.uni-muenster.de)



DR. MARTIN MATZNER

P +49 251 83-38088  
[martin.matzner@ercis.uni-muenster.de](mailto:martin.matzner@ercis.uni-muenster.de)





## Communication technology and wellbeing

While technology has increased opportunities for distributed collaboration and knowledge sharing, the downside of the induced organizational changes has become evident: we found profound structural changes in organizations as a result of systematic use of ICT, such as increased pace of processes and work, high levels of fragmentation and multi-tasking, as well as blurring boundaries between work and leisure time. These changes do not only affect employees' productivity and creativity but also their wellbeing and health.

In our research we identify the level and causes of occupational stress. At an organizational level this espoused and lived values and perceptions regarding communication policies, culture and ideas about the future workplace as well as the pace of the organization.

Our exploratory research pursues a holistic approach and conceptualizes occupational stress as the result of organizational parameter, such as leadership or task structure, individual and group characteristics, such as work practices and coping strategies, moderated by personality.

Our research uses a carefully configured multi-method research design, combining structural, behavioral and physiological parameters. Our data collection methods include interviews, observations, diaries and heart rate variability measurements.

The goal of our research is not only to sensitize organizations, groups and individuals to the detrimental effects of technology use, but to illustrate tangible ways to design smarter organizations that facilitate their members' wellbeing.

[www.wi.uni-muenster.de/wi/research/projects/hrv.html](http://www.wi.uni-muenster.de/wi/research/projects/hrv.html)

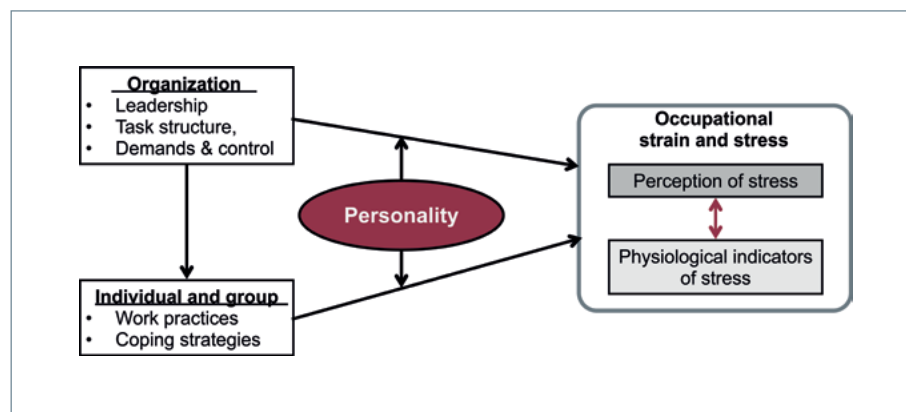

Figure 1: Analysis framework

## SMARTER WORK

The **Competence Center for Smarter Work** provides research and transformation support in the area of Unified Communication & Collaboration (UCC) and Social Media. UCC as well as social media facilitate extended and richer modes of interaction among stakeholder. Customer relations as well as partner communities can be actively transformed by the introduction of UCC and Social Media. Furthermore, tools can be used to improve cooperation among employees, to strengthen social relations or to identify experts and specific information.

The integration of these technologies and related concepts into the workplace provides profound challenges and opportunities for organizational development and innovation. We engage in detailed multi method workplace studies in order to gain deep insights into existing work practices. Based on the information and communication patterns (genre) and the relationship network of different stakeholders, we suggest scenarios for new work practices and transformation paths. In our scenarios for smarter work we also reflect issues of corporate social responsibilities and employee wellbeing.

## Bring Your Own Application (BYOA)

In a joint project with NextiraOne and Cisco we are developing a solution to support today's knowledge worker and their growing technological needs. Because of the continuing technologization of the personal life, the living room has replaced the workplace as location for technological innovation. Today's employees want to use the technology that is shaping and enhancing their personal lives also for their professional lives. This not only raises issues of liability, compliance with corporate policies, and integration of private devices (BYOD) into professionally managed networks. Moreover, additional challenges relate to the integration of the privately managed software and data into enterprise (legacy) systems.

Together with our partners we are developing a conceptual and a prototypical solution. The concept will be independent of hardware ownership and administration. The project addresses three aims: 1. Integration of legacy and cloud based services for data storage as well as processing, 2. Assurance of secure data storage and processing, and 3. Embedding of governance structure to guarantee data sovereignty.

## PUBLICATIONS

Kramer, M., Schallenmüller, S., & Klein, S. (2013). Drink your own champagne: Analysis of the transformation of a technology provider with Real Time Collaboration from a strategic and organizational point of view. In 26<sup>th</sup> Bled eConference elnnovations: Challenges and Impacts for Individuals, Organizations and Society (pp. 1–17). Bled, Slovenia.

Schellhammer, S., Haines, R., & Klein, S. (2013). Investigating Technostress in situ: Understanding the Day and the Life of a Knowledge Worker Using Heart Rate Variability. In Proceedings of the 46<sup>th</sup> Hawaii International Conference on Systems Sciences (HICSS).

## CONTACT DETAILS

### COMPETENCE CENTER SMARTER WORK

University of Münster  
ERCIS – Competence Center Smarter Work  
Leonardo-Campus 11  
48149 Münster, Germany  
[smarterwork@ercis.de](mailto:smarterwork@ercis.de)  
[www.smarter-work.de](http://www.smarter-work.de)



**MALTE KRAMER**  
MScIS, Managing Director

P +49 251 83-38113  
[malte.kramer@ercis.de](mailto:malte.kramer@ercis.de)



**SIEGFRIED SCHALLENMÜLLER**  
Bsc., Msc, Head of Advisory Board

P +49 251 83-38144  
[Schallenmueller@ercis.de](mailto:Schallenmueller@ercis.de)



**PROF. DR. STEFAN KLEIN**  
Academic Director

P +49 251 83-38110  
[stefan.klein@ercis.de](mailto:stefan.klein@ercis.de)

Schellhammer, S., Haines, R. (2013, forthcoming). Towards contextualizing stressors in technostress research. In: Proceedings of the 2013 International Conference on Information Systems (ICIS), Milan, Italy.



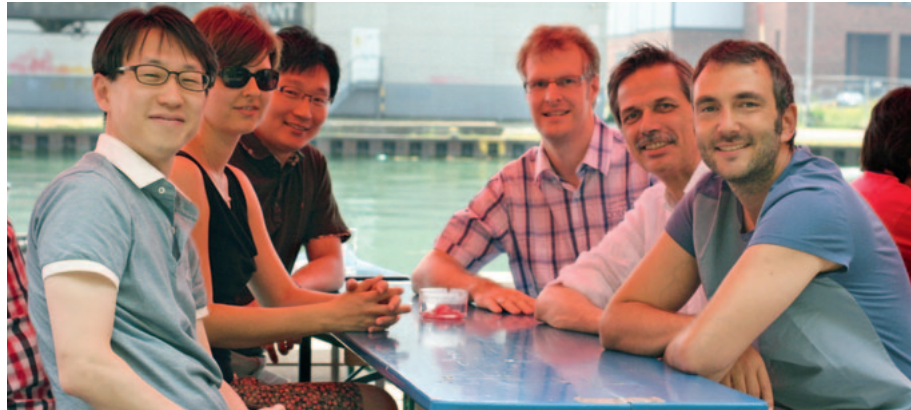

## ▶ NETWORKED SERVICE SOCIETY

The German Federal Ministry of Education and Research has launched a series of research projects to establish joint research structures with institutions in the Asian-Pacific region. Researchers of the ERCIS member institutions WWU (Münster, Germany), Queensland University of Technology (QUT, Brisbane, Australia), Ulsan National Institute of Science and Technology (UNIST, Ulsan, Korea), and Waikato University (Hamilton, New Zealand) collaborate to theorize on and design the “Networked Service Society” (NSS). Having started in 2010, the project will be funded by the BMBF until the end of 2014.

## ESTABLISHING A GLOBAL SERVICE RESEARCH CENTER

In the project we focus on establishing a center for global service research. In a first step, we initiated lively research collaborations between the ERCIS Partners in Australia, Germany, Korea, and New Zealand. In a second step, we plan to extend these collaborations with selected universities in the BRICS countries in order to research on service phenomena on a global scale. The long term vision is to institutionalize a global service research center, focusing on joint research, joint education, and joint industry projects.

## Joint Research

With the rise of the service economy, the prosperity of industrial countries is more than ever based on engineering, selling, and delivering highly advanced services. In addition, breakthrough innovations in IT enable companies, public administrations, and individuals around the globe to network in near real-time. Against this backdrop, flexible and efficient networking is an essential prerequisite for companies to enter and serve their markets globally. The mission of the NSS project is to contribute to theory and to the innovative design of IT artifacts in two research areas: Business Value of Social Media and Service Business Process Management.

## Business Value of Social Media

Social media, in particular online social network sites such as Facebook, are accessed by numerous people anywhere and anytime, free of charge. Companies and local governments increasingly strive to capitalize on the data stored on these platforms. One specific field of research are enterprise social networks. This type of social media technologies reveals a massive potential for organizations to identify, develop, and implement innovative ideas.

In 2013, we conducted a study to identify the success factors for developing innovative ideas in enterprise social networks and the conditions to implement them into companies. The project was carried out by QUT researchers Prof. Dr. Jan Recker and Dr. Thomas Kohlborn in cooperation with visiting ERCIS researcher Andrea Malsbender

and Dr. Daniel Beverungen from Münster. The study was carried out in cooperation with one of the top retail companies in Australia. We developed a conceptual model of success factors from innovations developed in enterprise social networks, which was published as a research in progress paper at the ICIS2013.

Another study conducted in 2013 analyzed the communication of local governments with their citizens on Facebook. Using a multi-method analysis of 15 941 posts and 19 290 comments on the Facebook pages of the 25 largest German cities, we identified the status quo and opportunities of utilizing social network sites by local governments. This stream of research was also advanced by a research visit of Dr. Stuart Dillon (Waikato Management School, Hamilton, New Zealand) to Münster. The results are currently being published in the renowned journal *Government Information Quarterly*.

## Service Business Process Management

Service companies face two major challenges. First, they need to distribute activities around the globe in order to maximize the local efficiency of their business units. Second, they need to synchronize these dispersed processes in order to keep their operation efficient and effective on a global level. We theorize on both tasks and design new solutions for companies to build up and run their business processes globally.

Finally, we conducted joint research on process mining in a Korean hospital. Process managers in this hospital observed great variety in the time their patients need to spend for ambulant treatment. In an attempt to improve the hospital's operational efficiency, Prof. Minseok Song (UNIST) cooperated with ERCIS researcher Dr. Martin Matzner in Ulsan. They applied process mining to both improve the service experience of the patients and to help the hospital with developing more efficient business operations. The idea and outset of this research endeavor were planned dur-

ing a research visit of the UNIST professors Minseok Song and Wooje Cho to Münster. During this visit, the respected Korean university UNIST also joined the ERCIS network, thereby greatly strengthening the research capabilities of ERCIS in East Asia.

## PAPERS PUBLISHED IN 2013

*Plattfaut, R., Hofmann S., Kohlborn T., Beverungen, D. (2013).* On the Design of IT Artifacts and the Emergence of Business Processes as Organizational Routines. In: Proceedings of the 34<sup>th</sup> International Conference on Information Systems (ICIS), Milan, Italy.

*Beverungen, D., Eggert, M., Voigt, M., & Rosemann, M. (2013).* Augmenting Analytical CRM Strategies with Social BI. *International Journal of Business Intelligence Research (IJBIR)*, 4(3), 32–49.

*Hofmann, S., Beverungen, D., Räckers, M., & Becker, J. (2013).* What Makes Local Governments' Online Communications Successful? Insights from a Multi-Method Analysis of Facebook. *Government Information Quarterly*, in press.

*Hofmann, S., Räckers, M., Beverungen, D., & Becker, J. (2013).* Old Blunders in New Media? How Local Governments Communicate with Citizens in Online Social Networks. In: Proceedings of the 46<sup>th</sup> Hawaii International Conference on System Sciences (HICSS-46), Maui, Hawaii.

*Malsbender, A., Beverungen D., Voigt M., & Becker J. (2013).* Capitalizing on Social Media Analysis – Insights from an Online Review on Business Models. In: Proceedings of the 19<sup>th</sup> Americas Conference on Information Systems (AMCIS), Chicago, IL, USA.

*Malsbender, A., Recker J., Kohlborn T., Beverungen D., & Tanwer S. (2013).* Much Ado About Nothing? Tracing the Progress of Innovations Borne On Enterprise Social Network Sites. In: Proceedings of the 34<sup>th</sup> International Conference on Information Systems (ICIS), Milan, Italy.

*Malsbender, A., Voigt, M., Beverungen, D., & Rosemann, M. (2013).* Digital Social Signal Processing – Theoretical Underpinning and Research Agenda. In: Proceedings of the Pacific Asia Conference on Information Systems (PACIS), Jeju Island, Korea.

*Plattfaut, R., Hofmann S., Kohlborn T., Beverungen D., Räckers M., Niehaves B. & Becker J. (2013).* Verwaltungsdienstleistungen für Personen mit eingeschränkter Mobilität: Von mobilen Bürgerdiensten zu E-Government?. *eGovernment Review*. 11, 14–15.

*Plattfaut, R., Kohlborn, T., Hofmann, S., Beverungen, D., Niehaves, B., Räckers, M., & Becker, J. (2013).* Unravelling (E-)Government Channel Selection: A Quantitative Analysis of Individual Customer Preferences in Germany and Australia. In: Proceedings of the 46<sup>th</sup> Hawaii International Conference on System Sciences, Maui, Hawaii, USA.

## Joint Education

We plan to further increase student and researcher mobility between the institutions involved in the project. From 2010 to 2012, a series of research visits to QUT, UNIST, WWU, and Yonsei University were conducted in order to initiate new cooperation. In particular, PhD students were given the opportunity to benefit from an international and leading-edge research setting. On an undergraduate level, we established exchange programs to increase student mobility. In 2013 two research visits of WWU researcher Andrea Malsbender were made to QUT. Ms. Malsbender's PhD thesis is jointly supervised by professors from WWU and QUT. On an undergraduate level, the first two students from Münster are spending away semesters at UNIST in Ulsan from 2013 to 2014, building on the cooperation agreement that was initiated by the NSS project in 2012.

In 2013, a joint virtual seminar was started in the ERCIS network, including various NSS partner organizations. The idea of the seminar is to establish a broader perspective on BPM education. The participating

students cooperate in multi-national work groups and organize their team virtually. In their projects, the students learn about managing BPM in internationally distributed settings. In the future, international summer schools will be conducted on an undergraduate and graduate level to further leverage joint education. The long-term goal is to foster a joint PhD program in ERCIS that improves the mobility of our PhD students.

## Joint Industry Projects

We strive to perform research cooperatively with service companies that manage their business processes globally and want to capitalize on the business value of social media. In the long-term, we aim at getting the planned Service Research Center funded from industry projects. In 2013 we developed a concept for conducting industry projects cooperatively. In 2013, research studies were carried out in cooperation with a leading retail company in Australia and with a hospital in Korea.

## CONTACT INFORMATION

The NSS project is managed by Daniel Beverungen, Armin Stein, and Andrea Malsbender (WWU, Münster). Project partners are Jörg Becker (WWU, Münster), Michael Rosemann (QUT, Brisbane), Junho Choi (Yonsei, Seoul), Minseok Song and Han Gyun Woo (UNIST, Ulsan), Jim L. Corner, Bob McQueen, Eric Deakins, and Stuart Dillon (University of Waikato, Hamilton).

The NSS project is funded by the German Federal Ministry of Education and Research (BMBF), promotion sign 01DR12003, from July 2010 to December 2014.





## › COLLABORATION IN THE AREA OF CRISIS MANAGEMENT AMONGST ERCIS PARTNERS

In June 2013 ERCIS Members from the University of Agder, Norway, and from the University of Muenster, Germany, came together with other acknowledged experts in the area of information systems for crisis management. Adam Widera, representing the Chair for Information Systems and Supply Chain Management at the University of Muenster, was invited by Prof. Tina Comes to join the initial workshop of the Centre for Integrated Emergency Management (CIEM) as an expert on humanitarian logistics and crisis management.

CIEM has established as a centre to bring together researchers from social sciences and technology to address the increasing need for better preparedness and emergency and crisis management. Our modern societies are increasingly threatened by and vulnerable to natural and man-made hazards. Novel technologies enable new forms of communication and collaboration. These need, however, still to be fully explored and exploited. The overall objective of the workshop was to discuss the future trends of information systems and the needs and most urgent challenges in crisis management. Here, very interesting ideas and opportunities have been found combining cutting edge research in technology, information systems and modelling.



*Participants of the CIEM Workshop on Information Systems for Crisis Management in Lillesand, Norway*

Both ERCIS members identified several opportunities for collaboration. They could already set a good example by jointly contributing to the ISCRAM (International Association for the Study of Information Systems for Crisis Response and Management) Summer School 2013 in August hosted at the Tilburg University with dedicated course on Humanitarian Logistics and Decision Support Systems in Crisis Management. The major challenges in humanitarian logistics are coordination and decision-making, while keeping track of the needs and a dynamically changing environment. To enable students to experience the difficulties in supply chain planning and operations, both topics have been not only presented theoretically but also integrated in the alternate reality game "Disaster in my Backyard" developed at the host university in Tilburg by Kenny Meesters and Bartel Van de Walle (see <http://www.iscramlive.org/portal/node/2780>).

The simulation exercise has been accompanied by the deployment of the mobile application GDACSmobile developed at the Chair for Information Systems and Supply Chain Management and the Joint Research Center from of the European Commission (see e.g. <http://irevolution.net/2013/03/27/gdacs-mobile-bounded-crowdsourcing/>).

The joint lecture on Humanitarian Logistics and Decision Support Systems in Crisis Management in combination with a hands-on simulation exercise has received very positive feedback by the audience.

Further research activities of both ERCIS members are planned and initiated. The results have shown that the ERCIS network offers an excellent environment for collaboration of our research activities in the field of crisis management. Are you also interested in this field and would you like to join us? In this case and for more information please do not hesitate to contact us: [tina.comes@uia.no](mailto:tina.comes@uia.no) and [adam.widera@ercis.de](mailto:adam.widera@ercis.de).

Further reading:  
<http://ciem.uia.no/>

<http://www.wi.uni-muenster.de/departments/groups/logistik>

<http://irevolution.net/2013/03/27/gdacs-mobile-bounded-crowdsourcing/>

## › RESEARCHER EXCHANGE BETWEEN ULSAN AND MÜNSTER



Managers at a hospital in Ulsan, Republic of Korea, were surprised to observe great variety in the time their patients need to spend for ambulant treatment, because it could not fully be explained by the duration of the actual treatment through the doctors. The managers supposed that the root cause of this problem could be due to the several different ways in which the administrative tasks that surround the treatment were organized internally.

In an attempt to mere the managers' understanding and to finally improve the hospital's operational efficiency, Prof. Minseok Song, PhD, from the School of Technology Management of ERCIS member University UNIST in Ulsan cooperates with ERCIS researcher Dr. Martin Matzner from Münster. Dr. Matzner therefore spent a research visit in August and September 2013 at UNIST in the context of the NSS project.

**The approach of the researchers:** they apply methods and tools from the domain of Business Process Mining in order to improve the service experience of the patients and to help the hospital becoming more efficient.

Process Mining is concerned with computing event data which is stored in the log files of the different information systems in the hospital in order to discover and improve processes. The picture above has been taken at a presentation to the faculty members of the Technology Management School.



## › GUEST RESEARCHER FROM FINLAND

Reima Suomi, our partner and Professor of Information Systems Science at the University of Turku, and part-time Professor at Huazhong Normal University, Wuhan, Hubei, China, visited the University of Münster as visiting researcher from March to May this year.

During his stay, Reima worked on topics around the management of networked activities, including issues such as management of telecommunication networks, electronic and mobile commerce, virtual organizations, and telework and competitive advantage through telecommunication-based information systems. The application of IS-enabled governance structures to the management of IS also belonged to the agenda, as well as the application of information systems in health care.

## › ROBERT WINTER FROM SWITZERLAND VISITS LUISS

Robert Winter (IWI-HSG, Univ. of St. Gallen) stayed at CeRSI (LUISS Rome) as a Guest Professor in April and June 2013. Hosted by Paolo Spagnoletti, he gave several guest lectures and enjoyed Rome in springtime. An offsite period is always a chance to realize long-planned projects such as reading and writing two new papers on design-oriented business research and a framework for emergent/inductive design research.

More important from a collaboration perspective is that Robert Winter joined Paolo Spagnoletti and Stefano Za in a research project on simulation in IS research that resulted in an accepted ICIS 2013 paper.

## › REIMA SUOMI VISITS UNIVERSITY OF ST. GALLEN

Professor Reima Suomi from University of Turku enjoys his sabbatical from teaching and administrative work made possible by a year-long grant from the Finnish Professor Pool financed by Finnish Cultural Foundation during the year 2013. During the year, Reima has an opportunity to dig deeper into the research topic of health care systems, especially that of using peer-to-peer support through social media in the field. During the autumn time Reima visited the University of St. Gallen, Institute of Wirtschaftsinformatik, as a visiting professor. Professors Walter Brenner and Robert Winter were his primary hosts there. During the visits, information with personal communications with local researchers could be collected, and there was a good possibility to prepare for joint projects and publications with local researchers. With the same purpose, he has already visited the University of Münster in Germany and Central China Normal University in Wuhan, China this year. The stay in St. Gallen was also integrated with visits to the University of Liechtenstein, where Reima also has a long-term co-operation history. The visit nicely takes place on the 20th anniversary of Reima's work as a "Vollamtlicher Dozent" in St. Gallen in the years 1992–1993.



## › STUART DILLON PRESENTS JOINT NSS PAPER AT THE HEADQUARTERS



Stuart Dillon (2<sup>nd</sup> from left) giving a talk at the ERCIS headquarters

On May 14<sup>th</sup>, Stuart Dillon (Waikato Management School, University of Waikato, Hamilton) presented a joint study funded by the NSS project in the Lunchtime Seminar held at ERCIS in Münster. The Lunchtime Seminar is a prime venue for inviting high profile researchers for guest presentations, held weekly at the institution.

In his presentation, Stuart provided an overview on the joint study on e-Government Transformation that was carried out in New Zealand, Queensland, and North-rhine-Westfalia. The study is a cross-national comparison of local e-government effectiveness from the perspective of the internal stakeholders. The findings indicate that e-government is viewed by the policymakers charged with developing it as something that supplements, rather than displaces, traditional government services. The corresponding research paper was presented by Stuart at the 9<sup>th</sup> International Conference on Web Information Systems and Technologies in Aachen, Germany, just a couple of days earlier.

## › MÜNSTER – HOBOKEN ENERGY RESEARCH

The group of Prof. Stephan Meisel at the University of Münster, Germany, and the group of Prof. Ricardo Collado at Stevens Institute, Hoboken, NJ, have initiated a close cooperation on energy systems research.

In particular the collaboration focuses on the many kinds of new dynamic decision problems arising in the context of modern energy systems management.

Today many companies dealing with energy systems are not only facing uncertain energy demands and volatility of energy prices, but they also have to take into account intermittent energy sources such as wind farms or solar power plants. Decisions about when to buy energy, when to sell energy or when to store energy in a battery for later use are very hard to make in the presence of the many sources of uncertainty involved.

Consequently new models and algorithms are needed in order to make sure that the decisions made over time lead to minimization of energy costs or maximization of profits from energy sales.

The two research groups found the combination of their respective research interests to closely match the needs of dynamic decision problems in energy systems management. The dynamic nature of the problems raises the need for anticipatory optimization, which is one of the key competences of the group at Münster. At the same time many energy systems cannot be managed without explicitly considering events like blackouts or price spikes, which tend to be both extremely unlikely and extremely costly. This requires risk-averse optimization, which is one of the main competences of the group at Hoboken.

One of the projects the groups have been working on deals with energy systems management for high-rises in cities like New York, where a single bad energy storage decision may lead to huge monetary penalties with potential losses of over \$400 000 in one billing cycle.

In another working project the groups take into account electricity market models in order to develop risk-averse anticipatory methods that allow companies to satisfy energy demands at minimal cost while deliberately controlling exposures to both price and demand variability.

The groups are looking forward to continuously extending their fruitful cooperation within the ERCIS network.



## › NITIMESR: MARIE CURIE INITIAL TRAINING NETWORK ON NETWORKED CRISIS MANAGEMENT

Two ERCIS members from the headquarters in Münster, Prof. Dr.-Ing Bernd Hellingrath and Prof. Dr. Stefan Klein have been awarded with a grant for a FP 7 Marie Curie Initial Training Network dedicated to research on networks in crisis management (NITIMesr). Funding from Europe's 7<sup>th</sup> framework program includes grants for 12 Ph.D. researchers and 4 Post Docs, who will work at seven institutions within Europe. These researchers will receive advanced research training combined with career development coaching both for university and industry. Extensive mobility phases will provide researchers with exceptional opportunity to broaden their experience while staying focused on their research project.

NITIMesr is part of NITIM, an international graduate research school. NITIM was founded in 2005 and is supported by an interdisciplinary network of researchers and faculty with expertise in the realms of networks, information, technology and innovation management. The key objectives of NITIM include; (i) functioning as a graduate research school that complements education of Ph.D. candidates in their home institutions; (ii) emphasizing engaged scholarship that underpins theoretically informed empirical research, as well as close collaboration with industry partners, organizations from the public sector, as well as NGOs; (iii) providing resources for faculty and Ph.D. candidates; (iv) acting as a cross-institutional and international entity; (v) maintaining an interdisciplinary perspective while concurrently building on a unifying set of theories and methods; and (vi) engaging the faculty and Ph.D. candidates in networking.

The EU grant acknowledges the maturity and quality of NITIMs career coaching processes for young researchers.

The aim of NITIMesr is (i) to rethink and transform management and governance principles for crisis management in net-

works that use advanced information and communication infrastructures, (ii) to develop and test innovative approaches for coordination in real world settings and (iii) to support the setup of Europe-wide connected clusters for crisis management. We assume such change to be systemic and radical in that it affects all command levels of crisis management, from policy making to individual behaviour.

The research program is designed as a practice-inspired research initiative that addresses

- research and conceptualization of new modes and competencies for coordination and collaboration in heterogeneous actor networks including involvement of individuals,
- advanced practices of vertically integrating governance of crisis management, strategic and operative management, down to operative humanitarian logistics to be able to observe performance differences in crisis management, with a special focus on
- involvement and engagement of self-motivated individuals, volunteers, citizens.

For further information please consult [www.nitim.org](http://www.nitim.org).

### CONTACT DETAILS

**Prof. Dr.-Ing. Bernd Hellingrath**  
P +49 251 83 38 000  
bernd.hellingrath@ercis.de

**Prof. Dr. Stefan Klein**  
P +49 251 83 38 110  
klein@ercis.de

**Adam Widera**  
P +49 251 83 38 011  
adam.widera@ercis.de



## › LUCA SABINI VISITS MANCHESTER



Luca Sabini from LUISS Guido Carli University has been for almost a year research visit at MBS invited by Prof. Daniel Muzio the first part of the year and by Dr. Damian Hodgson the second half on a project on the professionalization of project management. Luca's first objective has been to conclude his doctoral thesis. To achieve this objective the main activity has been the completion of a number of qualitative interviews with officials in project management associations both in Italy and the UK and their following transcription and coding. Luca's thesis seeks to understand (1) the occupational development of project management, (2) identify the strategies and tactics deployed by this occupation and (3) consider how these relate to more established patterns of professionalization.

The project also has a strong comparative dimension as it seeks to understand differences between the Italian and UK case with references to institutional differences between these two political-economies. One core finding emerging from the project is that whilst in the UK professionalization as a much more market oriented dimension, in Italy professional associations are seeking to a greater extent governmental sponsorship and statutory regulation.



## › ALEXANDER DREILING GIVES TALK AT THE HEADQUARTERS



On May 23<sup>rd</sup>, Ass. Prof. Dr. Alexander Dreiling (Queensland University of Technology, Brisbane, Australia) presented some of his work on airport innovations at the ERCIS Lunchtime Seminar in Münster. He has been driving IT and business innovation for the past 15 years in both industry as well as academia. Based at QUT's Information Systems School, as Associate Professor of Airport Innovation, Alex explores improving airport passenger and visitor experiences using digital channels.

In his presentation, he stated that QUT and Brisbane Airport Corporation have had a long-standing relationship in which they conducted projects in several areas such as sustainability, airport assets and master planning. More recently, the collaboration has been refocused on digital transformation led by the Chair of Airport Innovation with the goal of creating a world-best digital airport. As an international hub to Queensland's World Heritage listed tourism destinations as well as its capital Brisbane, the airport currently has around 25 million visitors annually and experiences strong passenger growth in all segments. Through a number of exciting research and teaching projects, QUT is driving digital innovation together with Brisbane Airport in order to transform customer experience and create value beyond the spatial boundaries of the airport and the temporal boundaries of air travel.



Øystein Sæbo from the University of Agder has been the main contact with the Italian team by establishing in 2012 a long-lasting cooperation with CeRSI-LUISS in the areas of social media and service governance. As a follow-up of this visit, and to strengthen the cooperation between these two ERCIS institutions, additional exchanges are planned in 2014.

## › RESEARCH EXCHANGE BETWEEN ROME AND KRISTIANSAND

On August 2013 Alessio Maria Braccini, Andrea Resca, and Paolo Spagnoletti, from the research center on information systems (CeRSI) of LUISS Guido Carli (Roma, Italy) were invited as international visiting scholars to join the Department of Information Systems of the University of Agder (Kristiansand, Norway). The Italian team has been involved in research activities within the E-Government group, and lecturing at bachelor and master levels.

In particular Alessio worked on a research project concerning the role of data and information diffused from direct source in the transparency of the relationships between stakeholders and large organizations/governments.

The second project is focused on design principles for organizing welfare and is related to the application of the Action Design Research method to the results of a EU project (AAL Joint Programme) in which both Paolo and Andrea have been involved.

## › GUEST RESEARCHER FROM THE UNIVERSITY OF TWENTE AT THE HEADQUARTERS

Since beginning of 2013, Dr. Erwin Folmer from the University of Twente stays as a guest researcher at the University of Münster. His research focusses on the Quality of Business Transaction Standards. With this, he currently works with the eGovernment group, with Dr. Michael Räckers in particular, on means to support the standardization of digital forms offered by the German public administration. The output is expected to be published in 2014.



<http://www.flickr.com/photos/ter-burg/8119058658/in/photostream/lightbox/>

## › JOINT PUBLICATIONS

*Becker, J., Beverungen, D., Knackstedt, R., Matzner, M., Müller, O., & Pöppelbuß, J. (2013).* Bridging the Gap Between Manufacturing and Service Through IT-Based Boundary Objects. *IEEE Transactions on Engineering Management*, 60(3), 468–482. A joint publication of the following ERCIS members: University of Liechtenstein; Information Systems and Information Management.

*Becker, J., Beverungen, D., Knackstedt, R., Matzner, M., Müller, O., & Pöppelbuß, J. (2013).* Designing Interaction Routines in Service Networks: A Modularity and Social Construction-Based Approach. *Scandinavian Journal of Information Systems*, 25(1), 37–68. – A joint publication of the following ERCIS members: University of Liechtenstein; Information Systems and Information Management.

*Beverungen, D., Eggert, M., Voigt, M., & Rosemann, M. (2013).* Augmenting Analytical CRM Strategies with Social BI. *International Journal of Business Intelligence Research (IJBIR)*, 4(3), 32–49. (In press) - A joint publication of the following ERCIS members: Queensland University of Technology; Information Systems and Information Management.

*Bruns, I., & Luhn, S. (2013).* Verbraucherschutz durch Mitentscheidung bei Online-Verträgen. In *Proceedings of the Law as a Service (LaaS) — Recht im Internet- und Cloud-Zeitalter, Tagungsband Herbstakademie 2013*, Berlin, 859–874. – A joint publication of the following ERCIS members: IT Security; ITM – Civil Law.

*Malsbender, A., Recker, J., Kohlborn, T., Beverungen, D., & Tanwer, S. (2013).* Much Ado about Nothing? Tracing the Progress of Innovations Borne on Enterprise Social Network Sites. In *Proceedings of the 34th International Conference on Information Systems (ICIS)*, Milan, Italy. (Accepted) - A joint publication of the following ERCIS members: Queensland University of Technology; Information Systems and Information Management.

*Malsbender, A., Voigt, M., Beverungen, D., & Rosemann, M. (2013).* Digital Social Signal Processing — Theoretical Underpinning and Research Agenda. In *Proceedings of the Pacific Asia Conference on Information Systems (PACIS)*, Jeju Island, Korea, 1–12. – A joint publication of the following ERCIS members: Queensland University of Technology; Information Systems and Information Management.

*Möser, M., Böhme, R., & Breuker, D. (2013).* An Inquiry into Money Laundering Tools in the Bitcoin Ecosystem. In *Proceedings of the APWG eCrime Researchers Summit (ECRIME 2013)*, San Francisco, USA. – A joint publication of the following ERCIS members: Information Systems and Information Management; IT Security.

*Pflanzl, N., Breuker, D., Dietrich, H.-A., Steinhorst, M., Shitkova, M., Becker, J., & Delfmann, P. (2013).* A Framework for Fast Graph-based Pattern Matching in Conceptual Models. In *Proceedings of the IEEE Conference on Business Informatics*, Wien, Österreich, Paper 28. – A joint publication of the following ERCIS members: Information Systems and Information Management; Computer Science.

*Plattfaut, R., Hofmann, S., Kohlborn, T., Beverungen, D., Räckers, M., Niehaves, B., & Becker, J. (2013).* Verwaltungsdienstleistungen für Personen mit eingeschränkter Mobilität: Von mobilen Bürgerdiensten zu E-Government?. *eGovernment Review*, 11, 14–15. A joint publication of the following ERCIS members: Queensland University of Technology; Information Systems and Information Management.

*Simons, A., vom Brocke, J., Fleischer, S., & Becker, J. (2013).* Conceptual Modeling of Electronic Content and Documents in ECM Systems Design. In *vom Brocke, J., & Simons, A. (Eds.), Enterprise Content Management in Information Systems Research: Foundations and Cases* (pp. forthcoming). Berlin, Heidelberg: Springer. (In press) – A joint publication of the following ERCIS members: University of Liechtenstein; Information Systems and Information Management.

*Stieglitz, S., Schallenmüller, S., & Meske, C. (2013).* Adoption of Social Media for Internal Usage in a Global Enterprise. In *Proceedings of the IEEE 27th International Conference on Advanced Information Networking and Applications (AINA)*, Barcelona, Spain, 1483–1488. – A joint publication of the following ERCIS members: Interorganisational Systems; Communication and Collaboration Management.

*vom Brocke, J., Braccini A.M., Sonnenberg C. and Spagnoletti P. (in press)* Living IT Infrastructures – An Ontology based Approach to Align IT Infrastructure Capacity and Business Needs, *International Journal of Accounting Information Systems*. A joint publication of the following ERCIS members: University of Liechtenstein; LUISS Guido Carli University Rome.

*Widera, A., Dietrich, H.-A., Hellingrath, B., & Becker, J. (2013).* Understanding Humanitarian Supply Chains — Developing an Integrated Process Analysis Toolkit. In *Proceedings of the International Conference on Information Systems for Crisis Response and Management (ISCRAM) 2013*, Baden-Baden, Germany. A joint publication of the following ERCIS members: Information Systems and Information Management; Information Systems and Supply Chain Management.

*Winter R., Spagnoletti P., Za S. (2013)* Exploring Foundations for Using Simulations in IS Research, *International Conference on Information Systems*, Milan 15–18 December. A joint publication of the following ERCIS members: University of St. Gallen; LUISS Guido Carli University Rome.

*zur Muehlen, Michael; Recker, Jan. (2013).* "We still don't know how much BPMN is enough – but we are getting closer.", *Seminal Contributions to Information Systems Engineering*, Bubenko, J.; Krogstie, J.; Pastor, O.; Pernici, B.; Rolland, C.; S Iberg, A., Springer. 2013 445-452. A joint publication of the following ERCIS members: Stevens Institute of Technology; Queensland University of Technology.





### › JOINT BITCOIN SEMINAR

Bitcoin is an emerging virtual currency which – contrary to the traditional currencies – does not require a central control mechanism. The Bitcoin users' bank balances are rather retained locally via a peer-to-peer network. By using all users' combined computing capacity, manipulation attempts are prevented.

This topic implies a number of research questions which have been worked on by students in the context of a simulated research conference. In doing so, the students prepared first versions of their seminar theses which had to undergo a peer-review process. After revising their submissions, the students handed in their final versions and presented their results during a final presentation.

One participant in the seminar, Malte Möser, won the best paper award at the "eCrime Research Summit 2013" in San Francisco with his paper "An Inquiry into Money Laundering Tools in the Bitcoin Ecosystem".

The seminar was organised by Dominic Breuker (Chair for Information Systems and Information Management) together with Prof. Dr. Rainer Böhme (IT Security Research Group).

### › JOINT SEMINAR

#### CYBER-PHYSICAL SYSTEMS

Cyber-physical systems (CPS) refer to constellations where the monitoring and control capabilities of several embedded systems (including sensors and actuators) are connected with remote services via global network structures. CPS are an enabler for extended system functionality and innovative business models. In this seminar, "smart factories" were selected as an exemplary application of CPS. 17 master's degree students were given the task to review the extant literature, to structure the field as a whole, and to identify prospects for future research.

Three subject areas were addressed:

- (1) The identification of meaningful events in the context of maintenance processes and the selection of promising compensation strategies in response to event observation.
- (2) The study of process analytics methods and tools that assist in analyzing and monitoring processes in the CPS.
- (3) The analyses of innovative "smart factory" applications of CPS in the production context.

The seminar was arranged by the ERCIS member groups of Prof. Dr. Jörg Becker and Prof. Dr. Bernd Hellingrath. The seminar was organized by Dr. Daniel Beverungen, Dr. Carsten Böhle, Ann-Kristin Cordes, and Dr. Martin Matzner.



### › WWU BARCAMP 2013

The WWU barcamp has been held for the third time. Again, the research group for communication and collaboration management at University of Münster (page 28) organized the event. Barcamps can be described as an unconference. The agenda for those events is created by the attendees at the beginning of the meeting. Anyone who wants to initiate a discussion on a topic can claim a time and a space. Unconferences typically feature open discussions rather than having a single speaker at the front of the room giving a talk, although any format is permitted. This form of conference is particularly useful when the attendees generally have a high level of expertise or knowledge in the field the conference convenes to discuss.

*"I was already here last year. Again, it was well mixed, there was a variety of fascinating input, interesting topics and you could network with others. I'll be back next year!"*

The global topic of the BarCamp 2013 was social media. The event was broadly promoted on Twitter and Facebook and it was frequently mentioned in local newspapers and radio. At the beginning of the event, several topics were proposed by the participants e.g. "Google Glasses" or "Social Seating – Find your life partner in the plane". Everyone who prepared a topic had the opportunity to promote it in the introduction round. This year, we offered four parallel sessions in different rooms during one period. In total, we had almost 95 participants and performed 20 sessions. The topic "Cars in the Digital Age" was awarded for the best session at WWU BarCamp. The session leader won a Surface Pro Tablet PC.

Other topics that have been discussed at the barcamp are: Google Glass – Ready for Information overkill, Social Media & Book on Demand, Social Seating – Find your life partner in the plane, Murder of Newspapers, Customer Co-Creation, 7i-Capgemini Vision of Deutschland, Web 3.0 – Semantic Web, Individuality in Social Networks, Cars in the Digital Age, Digital Suicide = Social Suicide, SimyoBarCamp Sponsoring, Stress & Envy in Social Media, UGC – Power and Possibilities, YouTube – Germans biggest Network, Social Media Protest, Exphone, Smartphone – Blessing or Curse, Bang with Friends, Is E-Mail dead?, Social Stalking

*"I held a session about Google Glass, which was a great experience. The barcamp really is a creative and informative event that broadens your view and gives you new insights."*

Stefan Stieglitz and Tobias Brockmann opened the barcamp and moderated it the whole day. Both were very content to see a growing public interest and a high engagement of the participants.



BarCamp Session I

In 2013, students from different disciplines participated in the barcamp (e.g. Information Systems, Business Administration, Biology, Linguistics, and Theology), as well as young entrepreneurs, practitioners and academics. As it is typical for barcamps, participants used the micro blogging service Twitter to share their experiences on the event publicly. The hashtag #wwubc has been established to interlink the communication about the event. While the barcamp took place 43 authors published altogether 213 tweets.

The barcamp was supported by several organizations such as Microsoft, LWL, Virtimo, 3CO, Zweitag, Capgemini, Connectiv! eSolutions, items, noventum, Sparkasse Münsterland Ost, viadee, AlumniUM and WINet. Representatives of those sponsors actively participated in the sessions and started vivid discussion with the students.



BarCamp Session II

We welcome everybody to visit the WWU Barcamp's website:

<http://www-barcamp.mixxt.de/>





## › JOINT ERCIS SEMINAR

3<sup>rd</sup> ERCIS Virtual Seminar took place during the Winter Term 2013/2014 and this time was opened not only for ERCIS Partner Institutions, but also for external universities. As a result, 60 students from 7 universities, namely the University of Muenster, the University of Liechtenstein, the University of Twente, the Ulsan National Institute of Science and Technology, the University of Tartu, the University of Minho, and the Athens University of Economics and Business, participated in the Seminar.



...T...Systems...

## › BPM WINTER SCHOOL 2013

In 2013 the Hilti Chair of Business Process Management (BPM) at the Institute of Information Systems of the University of Liechtenstein for the third year in a row organized BPM Winter School in Vaduz, Liechtenstein. Students from more than seven countries participated in the Winter School, where they could gain a comprehensive understanding of the BPM discipline during a five day intensive course.

Furthermore, the students visited such local companies as Hilti and Swarovski and could gain insights into their business processes. The participants also had a chance to establish new contacts and just have a lot of fun during evening social events.

[www.bpm-education.org](http://www.bpm-education.org)



The classes were held by BPM experts from both academia and practice. Participants had an opportunity to immediately apply the concepts and methods learned by working on case studies and exercises. The topics covered within the BPM Winter School include introduction to BPM, methods along the BPM lifecycle, process-aware Information Systems, alignment of BPM with corporate strategy, governance of BPM programs and projects, human factors in BPM, and culture in BPM.

The students were divided into 15 groups and had to set means of virtual collaboration with each other and to jointly work on an announced topic. This time the Seminar task was to design an innovative approach for B2C interaction in form of a (web-based) prototype, a movie or a concept. All developed solutions took part in the 2014 Hilti IT Innovation Competition. The goal of the Competition was to envision, how the future communication and collaboration between Hilti ([www.hilti.com](http://www.hilti.com)) and its customers, as well as within Hilti, might look like. The students had to submit their innovative ideas to Hilti directly, and then present them during a mid-term presentation. Afterwards they had to write seminar papers based on the developed solutions and present the papers during a final presentation in Liechtenstein. Moreover, students had to regularly report on their virtual collaboration experiences by filling the provided Agility Portfolios.

The intention of the Seminar is to enrich education in the Information Systems field by supporting students from the participating institutions in development of such soft skills as internationalization, virtualization, and collaboration. It is believed that such skills are crucial for their future career. The Seminar outcomes are intended to be published as an ERCIS Working Paper.

[virtual-seminar.ercis.org](http://virtual-seminar.ercis.org)

## › GERMAN-RUSSIAN SEMINAR EDUPASS

The project seminar EDUPASS was conducted in SS2013. The two main goals of the EDUPASS project included analysis and adaptation of the academic situation at Voronezh State University to the industry needs and European standards as well as investigation of promising new business areas for T-Systems CIS in Russia.

The seminar was officially started on 11<sup>th</sup> of April in the course of the SAP Forum 2013 at Crocus Expo in Moscow (Russia). The student team consisted of four master students of Information Systems from the University of Münster, four business informatics students from the National Research University Higher School of Economics in Moscow and Nizhny Novgorod and two students from Voronezh State University (VSU). The project was initiated and sponsored by T-Systems CIS and was supported by Voronezh State University, the European Research Center for Information Systems (ERCIS), Higher School of Economics in Moscow as well as SAP as part of their “University Alliance” program. The EDUPASS project seminar marks the third time the University of Münster and the National Research University Higher School of Economics in Nizhny Novgorod and Moscow collaborate in suchlike project.



During the seminar the students have got a great professional as well as social experience. They made two visits to Russia. The first trip was done in April for the project kickoff in Moscow and initial project phase in Voronezh. During the visit to Voronezh the students had a chance to talk to the T-Systems employees and managers, as well as to the students and academic staff of the Voronezh State University. The second trip was conducted in July when the students did their final presentation to T-Systems CIS in Moscow. Also the Russian participants had a chance to visit Münster for a week in order to analyze best practices of academic-industry collaboration and students’ international exchange in the University of Münster and make interviews with the representatives of T-Systems AG in Berlin.

The results, which the students achieved during the seminar, were of great value for the project stakeholders: T-Systems CIS and the Voronezh State University, who promised to use them in their future projects. The seminar was officially finished in September 2013 at the SAP Academic Alliances conference in Munich, where the students had a chance to shortly present the project to the audience.







## › ERCIS ADVISORY BOARD MEETING 2013

In September, the annual ERCIS Advisory Board Meeting took place at the ERCIS headquarters in Münster. As the ERCIS advisory board had noticeably grown in 2013, we could report a new record in the number of participants in this year's meeting. Besides researchers from the ERCIS headquarters, representatives of the member companies arvato Bertelsmann, Bison Maxess GmbH, Deloitte Consulting GmbH, Detecon International GmbH, Johannes Räckers GmbH & Co. KG, IQ-optimize Software AG and zeb/ took part in the meeting. The event was characterized by inspiring discussions and a fruitful exchange of ideas both between advisory board members as well as between advisory board members and researchers.

After a short introduction by the academic director Jörg Becker, Armin Stein, the managing director, presented a recap of the ERCIS activities in 2013. Furthermore, we had two interesting talks on current research projects at the ERCIS headquarters: Jens Lechtenböcker working at the Chair of Gottfried Vossen gave a presentation on big data and announced the launching of a Big Data Lab for SME in Münster. His talk was followed by an intensive discussion about the prerequisites of big data processing. Representatives from practice reported about their experiences with lacking data quality, which complicate the creation of meaning insights from data.

Furthermore, Stefan Stieglitz and Tobias Brockmann from the Communication and Collaboration Research Group presented their research results on the topic "Bring your own device". They analyzed the development of knowledge workers using their own mobile devices for their professional work. Many advisory board members acknowledged that they were facing this issue as well and could report about their experiences.

In addition to the news about current research projects, Florian Bernauer from Bison Maxess presented an innovative approach of cloud storage and talked about the challenges Bison Maxess is facing. His talk was followed by a lively discussion with the other advisory board members.

Further discussed topics were project seminars at the University of Münster, which are of high interest to the advisory board members. Information systems students have to work on a real-world problem in a project in cooperation with companies from practice.

All in all, the ERCIS Advisory Board Meeting 2013 was a further step towards a lively network and a fruitful dialogue between research and practice. Like every year, the day passed by too soon and we were left with a lot of interesting ideas for future collaborations. We are looking forward to our next meeting in 2014!



## › ICIST 2013 CONFERENCE

On October 10–11, Kaunas University of Technology hosted the 19<sup>th</sup> Annual International Conference on Information and Software Technologies – ICIST 2013. Formerly known as the IT Conference, the event turned international in 2008 and has since been organized by the Department of Information Systems of KTU. The ICIST 2013 Programme Committee included 72 professionals representing more than 40 academic institutions and four companies from 26 countries.

The aim of the Conference has always been bringing together practitioners and researchers aiming at everlasting convergence between business, software, and system requirements as well as the application of new supporting technologies. However, being a rather compact event, we felt the need to focus our attention on accentuating the strengths of our contributors and Program Committee members. Therefore, the topics this year were restructured to encourage the submission of papers in the fields of Information Systems, Business Intelligence, Software Engineering, and IT Applications. These topics have already become integral to societies at almost any level, forcing researchers to develop interdisciplinary approaches and to employ multidisciplinary ways of thinking. On the other hand, it is increasingly apparent that academia no longer holds the monopoly of scientific innovation. The need to bring scientists and practitioners together is as pressing as ever. This is exactly why the second day of the event was devoted

*Discussion panelists during the ICIST 2013 Industrial Tutorials, from left: A. Stonys, H. Jayatissa, D. Aksinavicius, J. Ditmore, J. Pitschke*

to the Industrial Tutorials of on software development practices by well-known practitioners. The event was co-located with ICIST for the fourth year in a row.

During the two days, there were ~40 presentations, including keynotes from such distinguished speakers as software engineering guru Prof. Paola Inverardi of the University of L'Aquila, enterprise modeling expert Dr. Jürgen Pitschke of BCS-Dr. Jürgen Pitschke, and seasoned IT executive Jim Ditmore of Allstate Technology and Operations.

In 2014, the Conference will be celebrating its 20<sup>th</sup> anniversary. If you happen to have some interesting research results you would like to share, consider submitting a paper to ICIST and maybe we will be able to celebrate together! Note that all Conference Proceedings are published by Springer as a volume of Communications in Computer and Information Science Series.

Conference homepage:  
[isd.ktu.lt/icist2013](http://isd.ktu.lt/icist2013)

Proceedings:  
[www.springer.com/computer/swe/book/978-3-642-41946-1](http://www.springer.com/computer/swe/book/978-3-642-41946-1)

## › IWEI 2013



The International IFIP (International Federation for Information Processing) Working Conference on Enterprise Interoperability (IWEI 2013) was hosted this year by the ERCIS partner in the Netherlands - the University of Twente. The Conference took place March 26<sup>th</sup> – 28<sup>th</sup>, 2013. IWEI 2013 is one of a series of conferences organized by the IFIP TC5 Working Group 5.8 on Enterprise Interoperability. The IWEI conferences are aimed at identifying and discussing challenges and solutions in the field of enterprise interoperability, both at business and technical levels. The IWEI 2013 program included a workshop on "Interoperability to support business – IT alignment" organized by the faculty members of the University of Münster Victor Taratoukhine and Martin Matzner and included a presentation of Ralf Plattfaut, also from the University of Münster, on "Process-Oriented Modelling".

For further information please visit [www.utwente.nl/ewi/is/events/IWEI2013/index.html](http://www.utwente.nl/ewi/is/events/IWEI2013/index.html)



## › 26<sup>TH</sup> BLED E-CONFERENCE



The Bled eConference is world's longest-running international eBusiness Conference, organized annually by the Faculty of Organizational Sciences, University of Maribor in the beautiful Alpine village of Bled. Every June, the Bled eConference attracts speakers and delegates from business, government, universities and information technology and e-service providers from around the world. With its fully refereed Research Track and Journal Partnerships, it is a major venue for researchers working in all aspects of "e." Beside research and business sections, the conference offers also special sections for students – Graduate students consortium and Students ePrototype bazaar.

This year, the 26<sup>th</sup> Bled eConference took place from June 9<sup>th</sup> to 12<sup>th</sup> under the title "eInnovation: Opportunities and Impacts on Individuals, Organizations and Society".



<http://BledConference.org>

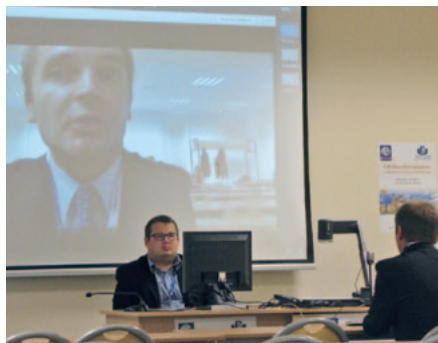

## › 6<sup>TH</sup> EUROSYMPOSIUM ON SYSTEMS ANALYSIS AND DESIGN

The 6<sup>th</sup> EuroSymposium on Systems Analysis and Design was held September 26<sup>th</sup>, 2013 in Gdansk, Poland. The event was organized by the Association for Information Systems (AIS) Special Interest Group on Systems Analysis and Design (SIGSAND), the Polish Chapter of AIS (PLAIS), and the Department of Business Informatics at the University of Gdansk. The EuroSymposium Proceedings were published in the Springer series Lecture Notes on Business Information Processing (LNBIP 161) with an acceptance rate of 40%. Scholars from the USA, Czech Republic, Israel, Lithuania, Germany, and Poland participated in the Symposium. The keynote speech was held by Prof. Nava Pliskin from Ben Gurion University (Israel). EuroSymposium participants were greeted by Prof. Jane Fedorowicz, Bentley University (USA) who is a current AIS president. Several papers at the 6<sup>th</sup> EuroSymposium were presented via videoconferencing. The next EuroSymposium will be held September 25<sup>th</sup>, 2014 in Gdansk.

For further information please visit <http://eurosymposium.eu/>



## › ICEC 2013

In August 2013, the 15<sup>th</sup> International Conference on Electronic Commerce (ICEC) with the special theme of Effective, Agile and Trusted eServices Co-creation was organized by the University of Turku. For the first time, it was held in Fennoscandia, a medieval Capital of Finland and Former Hanseatic League of Turku, Finland. It attracted participation from 15 countries, altogether 75 professionals from the fields of eCommerce and eServices. The conference dinner of ICEC 2013 took place in the king's hall at Turku Castle, the most important medieval castle in Finland. The acceptance rate of the papers was 50% for presentations. These were divided into two publications in Springer LNBIP 155 series and TUCS publications.







**ARVATO**

At arvato, more than 63,000 employees in over 35 countries work to bring daily success to business customers from all over the world and a wide range of sectors. They do this by designing and implementing tailor-made solutions for diverse business processes across integrated service chains. These include all services related to the production and distribution of print products and digital storage media, as well as data management, customer care, CRM services, supply chain management, digital distribution, financial services, qualified and custom IT services.

As an outsourcing service provider, arvato AG works in an exciting environment that is changing rapidly and constantly.

arvato's business units bring operative excellence, expertise and innovation to developing peerless outsourcing solutions for customers from many different sectors, from A (automotive) and H (healthcare) to T (telecommunication) and beyond.

With more than 110 sites worldwide and a highly flexible infrastructure, arvato provides its customers with a strong sales network and the international marketing channels of a global corporation.

**arvato and ERCIS – A strong partnership**

The European Research Center for Information Systems (ERCIS) and arvato have been linked by a series of successful projects since 2010.



Karsten Kraume (arvato) and Prof. Dr. Jörg Becker (ERCIS); find the full news on [www.ercis.com/news](http://www.ercis.com/news)

The collaboration began with the "M[i]Car" project, which encompassed the conceptualization and technical realization of an app that facilitates pre- and after-sales customer interaction. Practice-oriented instruction for the students and innovation for the company were successfully conjoined for the first time. Other "M[i]" projects followed in the subsequent semesters: "M[i] Sales – Mobile apps for sales support" and "M[i]Brand – Mobile apps allowing multi-channel interaction."

The interactive projects were rounded off by a **lecture on logistics management** in the summer semester 2011 and a **practice-oriented BSc thesis** in 2012.

"The cooperation between the University of Münster and arvato has proven very fruitful over the years. It contributes to innovation, and enhances our employer brand and network in academia as well as in business. Hence, joining the Advisory Board was the logical next step," comments Karsten Kraume, Vice President, arvato Corporate Information Management.

"We are delighted to welcome arvato, an exciting global player, on our advisory board," says Dr. Armin Stein, Managing Director of ERCIS, adding: "The areas that arvato works in as a global business process outsourcing provider are very interesting both for our researchers and our students."

**OUTLOOK**

arvato is open for various forms of collaboration both with different departments of ERCIS, but also with other member companies of the advisory board. Currently we discuss the following topics:

- the 4<sup>th</sup> seminar in the field of telematics
- further projects, e.g. in the field of industry 4.0

**If you are interested in collaboration with arvato as part of the European Research Center for Information Systems please contact:**

**Karsten Kraume**  
Vice President, arvato Corporate Information Management

P +49 5241 80 42764  
[karsten.kraume@bertelsmann.de](mailto:karsten.kraume@bertelsmann.de)



**ABOUT THE COMPANY**

Bison offers complete solutions for retail and is a leading supplier of merchandise management systems. Bison has its headquarters in Sursee (Switzerland), employs approximately 600 employees, and generates a turnover of over EUR 80 million. With over 30 years of market experience, Bison makes a reliable secure contribution to the success of its customers. Each customer receives a comprehensive and long-term support, with a focus on mutual trust and protection of customers' IT investments.

The Bison business solution was specifically developed for the retail sector. Bison Process enables a cross-channel sales approach and process management, and includes in-store, e-commerce and m-commerce. This business model supports retail-specific processes, which can be individually configured to meet the company's requirements, without programming and without losing the releasability of the software. Open architecture of Bison Process keeps the software a step ahead in the market, both in terms of its technological features and functionality.

In addition, the Bison product portfolio consists of Point of Sale (POS) solutions, Electronic Shelf Labelling (ESL), mobile solutions for iPhone, iPod and iPad, as well as digital signage solutions. Bison's cutting edge POS solutions can be perfectly integrated into existing system environments due to the modular structure and exceptional flexibility. The ESL concept allows a company's headquarters or in-

dividual branches to respond quickly to changing market or price environments. A wireless base station simplifies internal processes and creates a direct connection between a shelf and POS. A high quality display based on leading e-Paper technology guarantees optimum readability and no reflections on the screen. Bison offers financial advantages to customers thanks to its 'on demand' model. Investment costs for a retail company are reduced to a minimum. The 'all-round package', including hardware, software and services (support and maintenance), is covered by the monthly costs. Mobile solutions for the Apple Inc. products (iPhone, iPod and iPad) can be transformed into powerful handheld devices. The Bison scanning solutions include a barcode scanner, a magnetic card reader and an optional Bluetooth component to connect a mobile printer. The Bison applications can be standard or individually programmed and, therefore, offer a multitude of possibilities including stock-taking, order registration, receipt of goods or commissioning.

In addition to that, Bison offers innovative communication options through digital signage. The solutions can be managed efficiently due to a simple user functionality and automatic interfaces. In order to achieve maximum benefits, Bison supports customers as an independent integration partner. A competent support organization follows project implementation and provides assistance to ensure its smooth running.



The Bison Process can be extended by the QlikView Business Intelligence (BI) tool for a quick, simple and clear management control system. This optimal solution package can be integrated into existing system environments in order to ensure that a financial department has access to all important data.

**TOPICS OF INTEREST**

- European (sales) partnerships
- Development of new approaches (in particular, a cloud approach) to tackle retail-specific questions and problem areas
- Integration of the iPod, iPhone and iPad devices into operating procedures
- E-Paper integration options (e.g. Electronic Shelf Labelling)

**JOB OPPORTUNITIES**

- **For students:** Diploma/Bachelor theses in the fields of IT, software development and marketing
- **For graduates:** Consultants, software developers, project managers and sales representatives positions

For further information please visit [www.bison-group.com](http://www.bison-group.com)



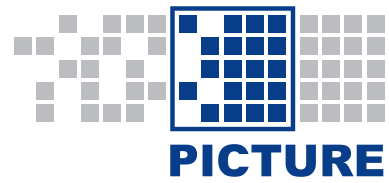

### ABOUT THE COMPANY

The PICTURE GmbH intends to promote organizations in their modernization efforts. We combine a methodical approach, technical support and considerable process expertise with a sustainable qualification approach. This integrated approach helps to achieve success in process management. The PICTURE GmbH was founded in 2007 by Lars Algermissen and Thorsten Falk as a spin-off of the University of Muenster. Thereby, the PICTURE GmbH stays connected with the University and benefits from a transfer of knowledge. The core business segments of the PICTURE GmbH are process consulting, process analysis and organizational design. The PICTURE GmbH is a consulting firm, as well as a software company with consultants and developers specialized in process consulting. The company is well-known for the PICTURE method and the PICTURE platform, combination of which allows description, analysis and optimization of business processes within organizations.

### THE PICTURE METHOD – Easy. Effective. Efficient.

Based on the 24 building blocks, the PICTURE method provides an opportunity to control processes by gathering and illustrating process data in a plain and transparent manner. This method of process modelling establishes a foundation for an extensive business assessment, as it offers a target-oriented and efficient way to analyze, whether a company's organizational structure and business procedures are coherent.

### THE PICTURE PLATFORM

The PICTURE method is embedded into the web-based PICTURE platform. This platform supports process management within organizations and inter-site projects. The PICTURE platform can be tailored to specific needs of organizations and is aimed at providing a vivid, precise and intelligible methodology to illustrate these needs through customized processes.

Please visit our website for further information: [www.picture-gmbh.de](http://www.picture-gmbh.de)

### JOB OPPORTUNITIES

Job Opportunities at the PICTURE GmbH:

- (Junior) Sales Consultant
- (Junior) Consultant
- (Senior) Consultant
- Software Developer
- Student Assistant

### TOPICS OF INTEREST

- Process Management and Optimization
- Quality Management and Risk Management
- Organizational Review
- Knowledge Management
- Task and Product Review
- Software Implementation
- Process Benchmarking
- Change Management
- Process-oriented Budgeted Consolidation
- Implementation of Document Management Systems
- Reorganization Studies
- Interface Analyses
- Implementation of Software



### ABOUT THE COMPANY

Firma Räckers is a medium-sized family company based in Germany, in the heart of the Münsterland region. The company's structures and processes are transparent and are aligned with modern requirements to businesses. The product portfolio is composed of standardized modules, as well as system solutions and special custom-made solutions. Customer satisfaction is the major goal of Firma Räckers and it is achieved by providing competent consultation, individual solutions and tailor-made systems.



The Räckers team consist of competent specialists and experts. Since the company's foundation, its personnel grew from 1 to approximately 200 employees. Structured distribution of areas of responsibility and close cooperation with renowned companies on national and international levels ensure the best outcomes.

Since the inception of Firma Räckers, its product range has been constantly extended. The company started with adhering rubber profiles in 1981. Now the service portfolio spans from raw materials processing to fully assembled end-products. In particular, Firma Räckers offers its customers CNC aluminium processing, CNC sheet metal processing, coating with chemical pre-treatment, assembly works, as well as industrial bonding and foam-moulding technologies. For many years Firma Räckers employs Just in Sequence production, which increases responsiveness of the whole team.

### FIGURES – DATA – FACTS

- 2 Executive directors
- 1 Authorised officer
- approx. 200 Employees
- approx. EUR 24 million 2012 Turnover
- 100 000 m<sup>2</sup> Plant area
- 20 000 m<sup>2</sup> Production area

Our company is particularly interested in implementation of theoretical “university knowledge” in practice. We are very delighted by the project seminar done by the BSc students from the University of Münster who helped us to prepare for quality management certification. The students analysed the current situation and proposed various possible solutions, which can be soon put into practice. E.g. in the future we plan to simplify the Just in Sequence field in order to further increase the responsiveness.

Please visit our website for further information: [www.raeckers.de](http://www.raeckers.de)





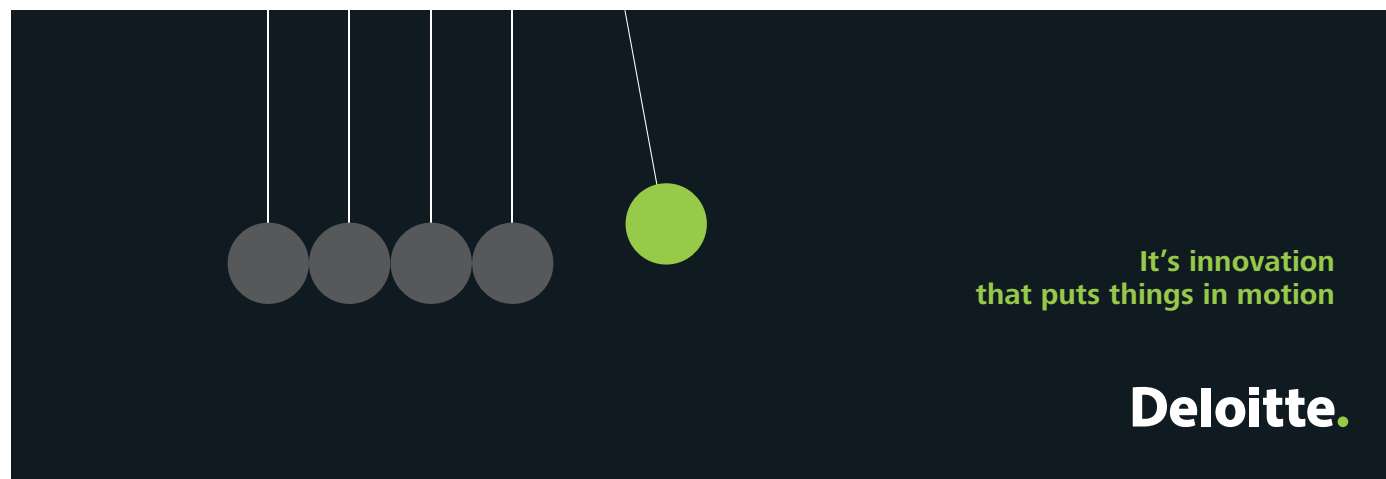

## Deloitte.

### ABOUT THE COMPANY

“Deloitte” is the brand under which nearly 200,000 professionals in independent firms throughout the world collaborate to provide audit, consulting, financial advisory, risk management, and tax services. With a globally connected network of member firms in more than 150 countries, Deloitte brings world-class capabilities and high-quality service to clients, delivering the insights they need to address their most complex business challenges. Our clients include renowned companies from around the world. 79% of the Fortune Global 500 companies are Deloitte clients. In 2013 Deloitte grew for fourth consecutive year, reporting US \$32.4 billion in revenue.

Deloitte is one of the world's leading, continuously fast growing global strategy consulting companies. As one member firm, Deloitte Consulting in Germany also offers a wide range of consulting services, including Technology, Human Capital, Strategy and Operations related services across all industries. As part of Deloitte Consulting, the Technology practice is supporting the CIO in addressing most complex business and IT challenges. The service portfolio encompasses IT Strategy, IT Architecture, IT Governance, IT Sourcing, IT Effectiveness, IT Mergers and Acquisitions, Information Management, Enterprise Applications, as well as SAP-related services. Over 280 practitioners from seven Deloitte offices in Germany are working with customers from various industries in multidisciplinary national and international teams to satisfy their needs. Forrester Research Inc. has named Deloitte a leader and “the gold standard” in IT organization redesigning in the analyst firm's report The Forrester Wave™: IT Organization Redesign Consultancies, Q4 2012.

### Topics of interest

Practice and industry studies are an integral part of Deloitte's service portfolio. In the CIO Survey 2013 we show what is on the agenda of about 700 CIOs around the world. We provide insights into the CIOs' perceptions of their roles inside their organizations and their viewpoint on what will be the trends which are worth future investments.

Deloitte is an innovation leader. We are seeking to interact with you, ERCIS member institutions, to explore the opportunities for developing efficient and innovative first class IT solutions to fulfil business strategies. We look forward to getting in touch with you, being your partner in providing real-life industry insights, and getting your inspiration as dedicated scientific institution.

### Job Opportunities

As integral part of our ambitious growth strategy, Deloitte and, in particular, Deloitte Consulting is always looking for graduates, young professionals and professionals having a desire to start their career at Deloitte. We offer workshops to provide you with an insight into what it is like to be a consultant. We are interested in having you as a participant of upcoming ERCIS project seminars and working with us on innovative solutions for current and upcoming CIOs' issues.

Are you interested? Then follow us on Facebook, watch out for news on the ERCIS website and visit [deloitte.com/careers](http://deloitte.com/careers) for open positions.



### ABOUT THE COMPANY

zeb/rolfes.schierenbeck.associates is one of the leading management consultancies specializing in the financial services sector with 17 offices in Germany, Austria, the Czech Republic, Denmark, Hungary, Italy, Luxembourg, Norway, Poland, Sweden, Switzerland, and Ukraine. zeb/ supports credit institutions, banks and IT service providers, as well as insurance companies and financial sales organizations. Our clients include large, regional and private banks, savings banks, federal state banks, insurance companies, institutions of the Cooperative Financial Services Network, as well as specialized commercial banks.

The company was founded in 1992 by Prof. Dr. Bernd Rolfes and Prof. Dr. Dres. h.c. Henner Schierenbeck in Münster (Germany) with an objective of meeting the growing need in consulting services by financial institutions. zeb/ soon positioned itself as a partner for financial service providers that assigns equal importance to design quality and practical implementation. Today more than 850 employees support our clients along the entire value chain. The zeb/group includes zeb/rolfes.schierenbeck.associates, zeb/information.technology, findic/, ITE competence, compentus/, and Resolving.

### TOPICS OF INTEREST

As a partner for change, we aim at improving performance and competitiveness of our clients by providing competent advice. Heterogeneous nature of the financial services sector requires tailored consultancy solutions. In order to meet these requirements, we focus on holistic customer support by assigning individual market managers, which is combined with know-how of our five Competence Units:

- Finance and Risk
- Information Technology
- Strategy and Sales
- Organization and Transformation
- Human Capital

We offer our clients the in-depth expertise of our employees in the financial services sector, our strategic know-how, as well as practical implementation experience. Moreover, our matrix organization is made up of domain experts and client relationship managers, which guarantees integral support of our clients through personal contact and consulting partners.

zeb/ employs the tools and equipment necessary to analyze and assess the upcoming challenges and to implement projects in a calculable manner. We do not only strive for exact solutions, but also for sustainable, measurable and long-lasting success. We are convinced that outstanding industry knowledge is essential to elaborate tailored solutions and concepts. As the European largest management consulting company specialized in financial services, it is of high importance for us to ensure that strategic intellectual expertise and excellent techniques are employed during the implementation process.

### JOB OPPORTUNITIES

- Consultants IT Strategy for Banks
- IT Consultants Business Intelligence
- IT Consultants/Senior Consultants Capital Markets
- Consultants SAP-Finance Transformation Banking

Additional career opportunities are posted at <https://recruiting.zeb.de/>





**COLLABORATION WITH ECWT**

The European Centre for Women and Technology provides a European level meeting place for 130+ leading public-private actors, academia and NGOs collaborating for measurably and significantly increasing the number of girls and women in technology in general and ICT in specific. ECWT serves as a European single point of contact for information, collection and analysis of data, research and the development of appropriate methodological tools to attract more girls to Science, Technology, Engineering and Mathematics (STEM), for nurturing and retaining women in the knowledge economy through industry and entrepreneurial careers, for promoting the female talent to provide added value to ICT solutions, for supporting more female ICT business start-ups and consolidating the largest network for closing the Digital Gender Gap in Europe.

The ECWT strategy is implemented through National Point of Contacts established in 21 countries (2013) hosted by key national public actors (CTI, Switzerland, Swedish Agency for Economic and Regional Growth, Malta Information Technology Agency), corporate companies (SAP and SAP Research), universities (Aalto University, Finland; CISRE Formazione Avanzata / Università Ca' Foscari Venezia, Italy; KIT – Germany, NTNU, Norway, Reykjavik Technical University), SMEs (Global Contact, France, PROMIS@Service Luxembourg, Zen Digital, Belgium; ), national ICT, telecom and trade associations (DI ITEK, Denmark, Intellect, UK; InfoBalt, Lithuania; PIIT, Poland) and NGOs (ATI, Spain; Bulgarian Centre for Women and Technology, Bulgaria; EWMD Portugal; Femei in Tehnologie, Romania; HEPIS, Greece; NaTe, Hungary, VHTO, The Netherlands).

End of 2013 ECWT celebrated its 5<sup>th</sup> year in action. Having been founded just before the global financial and economic crisis, sustaining our network was indeed a challenge. 2013, has, however, resulted in a real breakthrough for ECWT: involvement in the European Parliamentary Hearing on Women in ICT and in two European level and several national pledges for the Grand Coalition for Digital Jobs:



- WePROMIS® – to support women's business start ups and SMEs in taking up cloud based interactive services, multilingual content, e-Learning, compliance tools managed by PROMIS@Service and build communities of e-Mentors (STEM scientists and corporate business leaders) and Mentees (schools, universities) managed by ECWT
- the awareness raising initiative European Digital Girls / Digital Woman Award that was handed out for the first time at ICT 2013 in Vilnius;
- a national action plan Gender Diversity in Digital Jobs presented 10 December in France;
- a similar national action plan to be launched in Greece the 4 April 2014.

In 2013 ECWT has also been approved as member of the COST genderSTE Network as well as research partner in the FP7 SiS project: SEISMIC – Societal Engagement in Science, Mutual learning in Cities – A Mobilisation and Mutual Learning Action Plan: mainstreaming Science in Society actions in research.

We are proud to have ERCIS among our Members and believe that with the extended governance structure adopted from 2014 ECWT Alliances and ERCIS Competence Centres should be able to identify joint research priorities for working together within HORIZON2020.

Personally I am also confident that ECWT's Gender Action Plan that has resulted in an increase of female researchers at Simula Research Laboratory from 19% in 2009 to 26% end of 2012 should be of interest to ERCIS Members. I therefore look forward to closer interactivity between our networks!

**Eva Fabry**  
 Director of the European Centre for Women and Technology – ECWT  
 Secretariat  
 Grønland 58, N-3057 Drammen  
 Tel./GSM: +47 924 77 960  
[eva.fabry@womenandtechnology.eu](mailto:eva.fabry@womenandtechnology.eu)

[www.womenandtechnology.eu](http://www.womenandtechnology.eu)





### CHRIST

Jeweler and watch maker since 1863.

The Christ jewelry stores lead the market in Germany in the mid to upper price range of the jewelry and watches segment.



### DETECON INTERNATIONAL GMBH

Detecon International is one of the world's leading management consulting companies, one which combines classic management consulting with outstanding technological expertise. This approach of thinking in terms of these two areas simultaneously will determine the future performance of every company.

Our business is consulting, our strengths are digital technologies and networks. For more than 30 years, we have been supporting companies and telecommunications providers around the globe, helping them to improve the sustainability of their competitiveness and performance capabilities along the entire value chain with the aid of innovative technologies. Moreover, we offer our clients solutions in all fields of classic corporate consulting: strategy, organization, processes, and HR management.



### HILTI CORPORATION

Hilti provides leading-edge technology to the global construction industry. Hilti products, systems and services offer the construction professional innovative solutions with outstanding added value. The headquarters of the Hilti Group are in Schaan in the Principality of Liechtenstein. Some 21000 employees, in more than 120 countries around the world, entuse their customers and build a better future. The corporate culture is founded on integrity, courage, teamwork and commitment.

Hilti excels through outstanding innovation, top quality, direct customer relations and effective marketing. Two-thirds of the employees work directly for the customer in sales organizations and in engineering, which means a total of more than 200,000 customer contacts every day. Hilti has its own production plants as well as research and development centers in Europe, Asia and Latin America.

Founded in 1941, the worldwide Hilti Group evolved from a small family company. Since 2000, the Martin Hilti Family Trust holds all shares and, since January 2008, all participation certificates of Hilti Corporation. This safeguards the further development of the company founder Martin Hilti's life's work in the long term.



### IQ-OPTIMIZE

IQ-optimize Software AG is an innovative Software-Technology supplier with over 60 motivated employees, IQ-optimized develops, implements, and supervises software solutions for Business Process Management (BPM) and Workflow-Automation. Those solutions embrace all administrative and commercial domains of a company.

The core competence of IQ-optimize is the development and maintenance of web-based Workflow-Solutions and the integration of Software-Applications (EAI) for the improvement of business processes.



### SAP

As market leader in enterprise application software, SAP (NYSE: SAP) helps companies of all sizes and industries run better. From back office to boardroom, warehouse to storefront, desktop to mobile device – SAP empowers people and organizations to work together more efficiently and use business insight more effectively to stay ahead of the competition.

SAP applications and services enable more than 251000 customers to operate profitably, adapt continuously, and grow sustainably.

For more information, visit [www.sap.com](http://www.sap.com).



### STATE NORTH RHINE-WESTFALIA

North Rhine-Westphalia is the state "deep in the West" of Germany. It is located in the region between Selfkant in the West and Höxter in the East, Hellenthal in the South and Rahden in the North, and is home to some 18 million people who live on a surface area of over 34000 square kilometers.

This not only makes North Rhine-Westphalia the most populous of the 16 German states, it also means that more people live in this state than, for instance, in the Netherlands, Belgium, Austria or Switzerland. Nearly half of North Rhine-Westphalia's land area is used for agriculture, forests cover one quarter of the state's surface.

Altogether, North Rhine-Westphalia has 14 nature parks, some of which it shares with other states, and one national park, the Eifel. There are 29 cities with more than 100000 residents. The largest city in North Rhine-Westphalia is Cologne with a population of about one million while Düsseldorf is the state capital of North Rhine-Westphalia.



### UNIVERSITY OF MÜNSTER

The research profile of the WWU Münster is marked by a considerable number of research focal points of proven excellence: in the humanities (including the Theological Faculties), law, business administration, natural sciences, mathematics and medicine. For example the Leibniz Prize, also known as the "German Nobel Prize", has been awarded to WWU Münster no fewer than four times since 2003. The award-winners are Prof. Hubert Wolf (theology), Prof. Barbara Stollberg-Rilinger (history), Prof. Klaus Mezger (geochemistry) and Prof. Wolfgang Lück (mathematics).

The WWU increasingly offers modular courses of study leading to bachelor and master degrees. This not only makes international exchanges easier, but also ensures high-quality teaching which can compete with the world's best. The German Science Council (Wissenschaftsrat) also emphasises the quality of teaching at the WWU Münster.



## OUTLOOK FOR 2014

### JANUARY 2014

- European Privacy Day 2014, January 28, 2014, Vaduz, [www.uni.li/iwi](http://www.uni.li/iwi)

### FEBRUARY 2014

- Student Track at Multikonferenz Wirtschaftsinformatik 2014 (MKWI 2014), February 26–28, 2014, Paderborn, Germany, organized by the University of Liechtenstein, [www.mkwi2014.de](http://www.mkwi2014.de)

### MARCH 2014

- BPM Winter School 2014, March 2–7, 2014, Vaduz, [www.bpm-education.org](http://www.bpm-education.org)
- 33<sup>rd</sup> International Conference on Organizational Science Development: Focus 2020, March 19–21, 2014, Portoro, Slovenia, organized by the University of Maribor, [fov.uni-mb.si/conference](http://fov.uni-mb.si/conference)
- Kilpisjärvi Information Systems Seminar (KISS), organized by the University of Turku, March 23–29, 2014, [www.wis.fi](http://www.wis.fi)

### MAY 2014

- 2<sup>nd</sup> European BPM Round Table, May 15, 2014, Vaduz, [www.bpm-roundtable.eu](http://www.bpm-roundtable.eu)

### JUNE 2014

- 27<sup>th</sup> Bled eConference: “ e-Ecosystems”, June, 1–5, 2014, Bled, Slovenia, [BledConference.org](http://BledConference.org)
- 22<sup>nd</sup> European Conference on Information Systems (ECIS 2014), June 9–11, 2014, Tel Aviv, Israel, [www.ecis2014.eu](http://www.ecis2014.eu)

### AUGUST 2014

- 5<sup>th</sup> International Conference Well-being in the information society (WIS 2014), August, 18–20, 2014,
- IEEE Conference on Computational Intelligence and Games, August 26–29, 2014, Dortmund, co-organized by the University of Münster, [cig2014.de/](http://cig2014.de/)

### SEPTEMBER 2014

- ERCIS Annual Workshop, September, 10–12, 2014, Rome
- The 7<sup>th</sup> SIGSAND/PLAIS EuroSymposium on Systems Analysis and Design, September 25, 2014, Gdansk – Sopot, [eurosymposium.eu](http://eurosymposium.eu)

### OCTOBER 2014

- 20<sup>th</sup> International Conference on Information and Software Technologies – ICIST 2014, October 2014, Kaunas
- Information Society2013 – 17<sup>th</sup> International multiconference Education in Information Society, October 2014, Ljubljana, Slovenia, organized by the University of Maribor, [vivid.fov.uni-mb.si/](http://vivid.fov.uni-mb.si/)

### DECEMBER 2014

- 2014 International Conference on Information Systems (ICIS 2014), December 13–17, 2014, Auckland, New Zealand

## ERCIS TEAM

> ERCIS Team [www.ercis.org](http://www.ercis.org)



For everything that concerns the ERCIS network simply write an email to [team@ercis.org](mailto:team@ercis.org). You will for sure get an answer from one of our team members.

The team consists of Dr. Armin Stein, who is the managing director of the ERCIS network, as well as Dr. Katrin Bergener and the two PhD students Sara Hofmann and Marcel Heddier, who work part-time for the network during their PhD studies. Besides answering emails, the team helps organizing events, maintains the website, organizes the network communications, and supports project applications. If you are interested in the network, get in touch with them!



# THE IS RESEARCH NETWORK



## IMPRINT

PUBLISHER EUROPEAN RESEARCH CENTER FOR INFORMATION SYSTEMS (ERCIS)

EDITING DR. KATRIN BERGENER, MARCEL HEDDIER, SARA HOFMANN, DR. ARMIN STEIN

LAYOUT LIVING CONCEPT GRUPPE MÜNSTER 2013

ACADEMIC DIRECTOR PROF. DR. DR. H.C. JÖRG BECKER, PROFESSOR H.C. (NRU-HSE, MOSCOW)

LEONARDO-CAMPUS 3 48149 MÜNSTER, GERMANY BECKER@ERCIS.ORG

P +49 251 83-38100 F +49 251 83-38109

MANAGING DIRECTOR DR. ARMIN STEIN LEONARDO-CAMPUS 3 48149 MÜNSTER, GERMANY

STEIN@ERCIS.ORG P +49 251 83-38085 F +49 251 83-28085